

NEXUS

MULTI *Control*

- Instrument and Server -



Installation and Operation Manual

Navigation terms

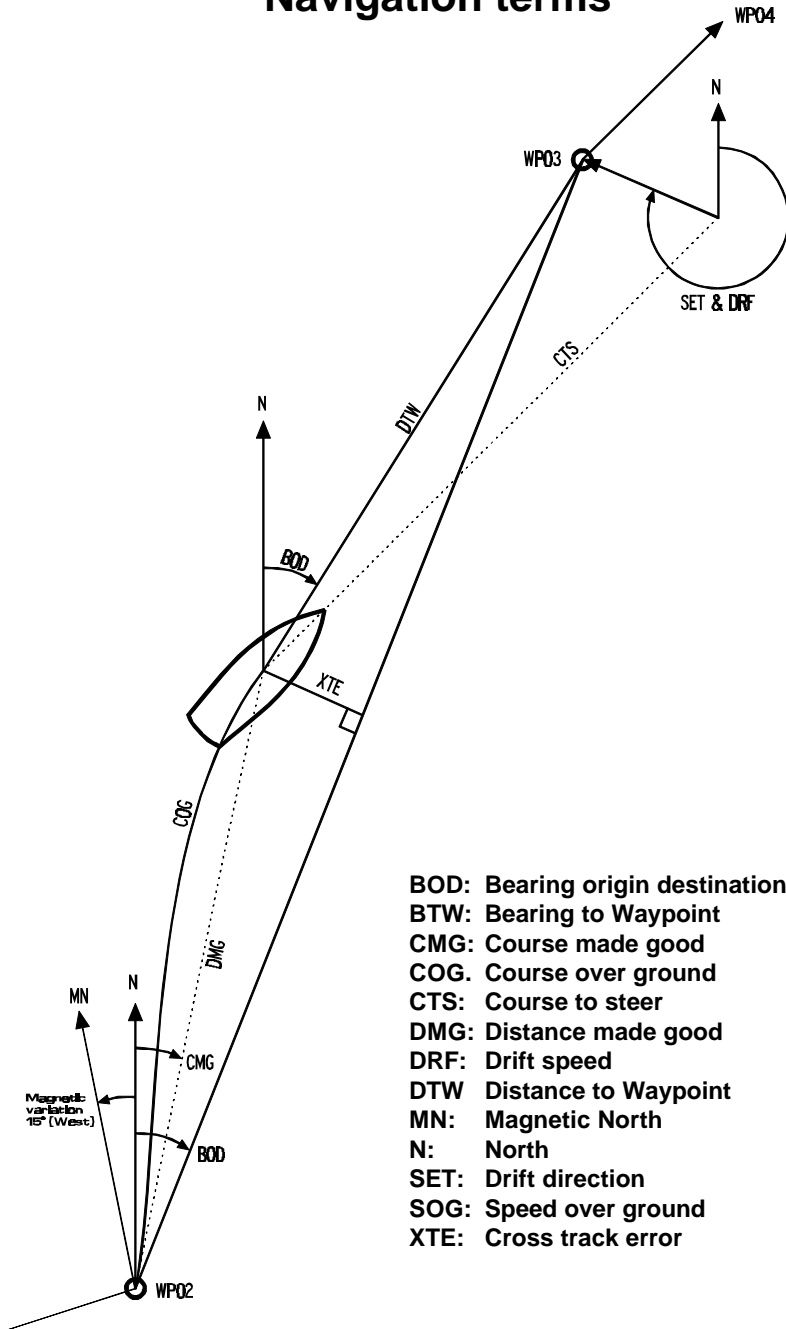

- BOD:** Bearing origin destination
- BTW:** Bearing to Waypoint
- CMG:** Course made good
- COG:** Course over ground
- CTS:** Course to steer
- DMG:** Distance made good
- DRF:** Drift speed
- DTW:** Distance to Waypoint
- MN:** Magnetic North
- N:** North
- SET:** Drift direction
- SOG:** Speed over ground
- XTE:** Cross track error

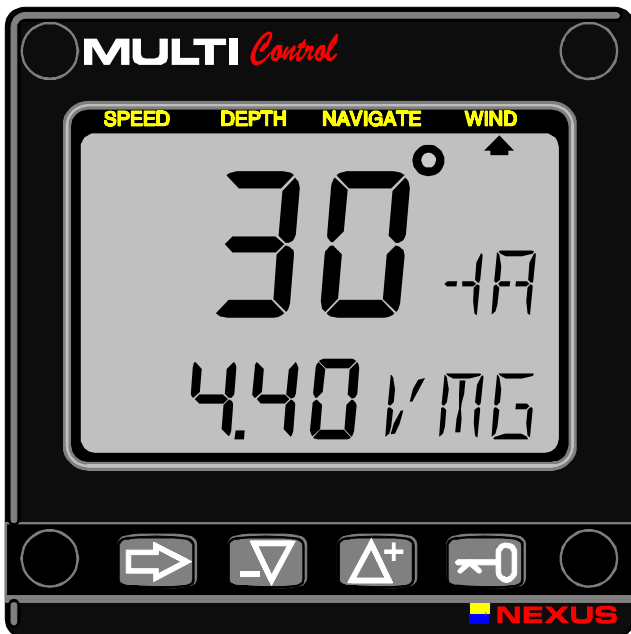

This manual is written for Nexus Multi Control and Server instrument version 2.00
Edition: June 2000

1 Part specification	7
2 Installation - Contents.....	9
2.1 Location of the Server	11
2.2 Installing the Server	11
2.3 Location of the instrument.....	12
2.4 Installing the instrument	12
2.5 Installing the transducers	14
2.6 Connecting optional accessories	14
2.7 Connecting instrument lighting	16
2.8 Connecting a NMEA instrument IN to the Server	16
2.9 Connecting a NMEA instrument OUT from Server	17
2.10 Connecting the power supply.....	17
2.11 Compatibility with our previous transducers.....	18
3 First star - Contents	21
3.1 Initialising the instrument	21
3.2 Re-initializing the instrument	21
4 Operation - Contents.....	22
4.1 About this manual	23
4.2 How to use the 4 push-buttons	24
5 Function overview - Contents.....	26
6 SPEED functions - Contents	27
6.1 SPEED main-function	28
6.2 SPEED sub-functions.....	28
7 Depth functions - Contents.....	30
7.1 DEPTH main-function	31
7.2 DEPTH sub-functions.....	31
7.3 Set and turn on shallow (SHA) and depth alarm (DEA).....	33
7.4 Set and turn on anchor alarm (ANC)	33
7.5 Clear an alarm value.....	33
7.6 Silencing an alarm	33
7.7 Turning off / on an alarm.....	33
8 NAVIGATION functions - Contents	34
8.1 NAVIGATION main-function.....	35
8.2 NAVIGATION sub-functions	35
8.3 Steer reference (Pilot)	36
8.4 Store and edit a waypoint (Edit WP).....	40
8.5 Create a sailplan (Goto WP)	42
8.6 Arrival alarm	46
9 Wind functions - Contents	47
9.1 WIND Main-function.....	48
9.2 WIND Sub-functions	48
9.3 Tactical function.....	50
10 Man over board (MOB) function	51

CONTENTS

11 Customise your display	52
11.1 Move and lock a sub-function	53
11.2 Copy and lock a sub-function	53
11.3 Select power on function	53
11.4 Cancel a moved or locked sub-function	54
11.5 Temporary locking of alternating functions	54
12 Calibration - Contents	55
12.1 Calibration of speed C10	57
12.2 C20, calibration of depth	58
12.3 C30, calibration of navigation	58
12.4 Compass calibration	60
12.5 C50, calibration of wind.....	62
12.6 C70, calibration of Network and NMEA.....	63
12.7 NMEA	65
12.8 Special NMEA sentences	69
13 Maintenance and fault finding	70
13.1 Maintenance	70
13.2 Fault finding	70
14 Specifications.....	74
14.1 Technical specifications	74
14.2 Nexus databus introduction and user policy	74
14.3 Optional Accessories.....	75
14.4 Abbreviations	77
14.5 Warranty.....	80

For more detailed contents specifications, see beginning of each new chapter

1 Part specification

Items delivered with the Server

Qty.	Description	Reference
1	Nexus Server	1
4	Server mounting screws	3
2	Plastic cable straps	3
1	Power cables, red and black, 3 m (9 ft) each	2

Items delivered with the instrument

1	Nexus Multi Control instrument	4
1	Instrument cover	5
5	Cable protectors, 0,25 mm (0.1 inch)	6
5	Cable protectors, 0,75 mm (0.3 inch)	6
4	Instrument mounting screws	7
4	Rubber caps for screws	7
1	Connection back cover	7
1	4-pole jack plug	7
1	Silicon paste tube	7
2	Plastic cable strap	7
1	Adhesive drill template for instrument	8
1	Nexus Network cable, 8 m (26 ft)	9
1	Quick guide laminated	10
1	Inter-connection cable, 0,3 m (1 ft)	
1	Installation and Operating manual	11
1	Warranty card	12
1	National distributor list	13

Registering this product

Once you have checked that you have all the listed parts, please take time to fill in the warranty document and return it to your national distributor.

By returning the warranty card, it will assist your distributor to give you prompt and expert attention. Keep your proof of purchase. Also, your details are added to our customer database so that you automatically receive new product catalogues when they are released.

Warranty conditions see 14.6.

PART SPECIFICATION



1

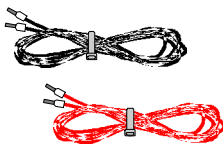

2

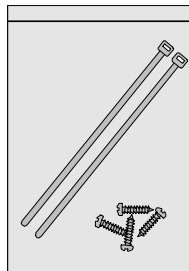

3

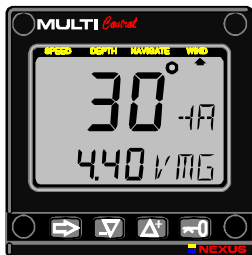

4

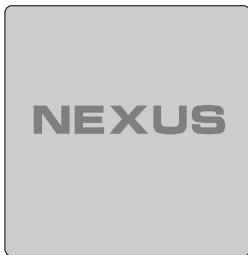

5

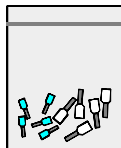

6

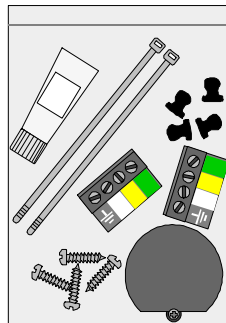

7

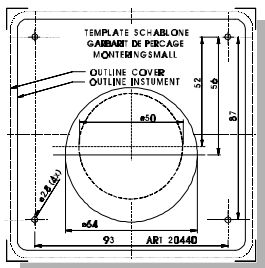

8

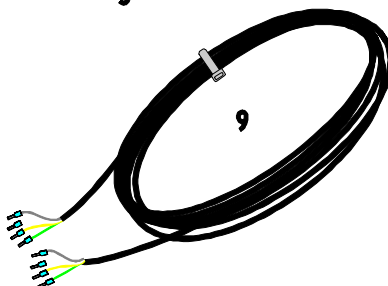

9

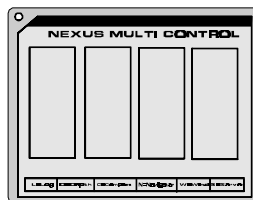

10

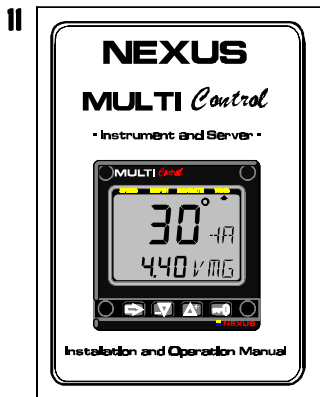

11

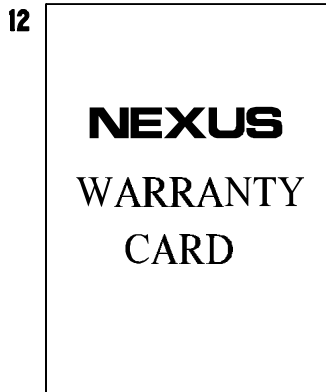

12

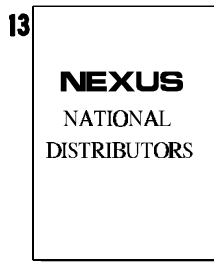

13

Welcome aboard the Nexus Network!

Thank you for choosing Nexus and welcome to the world of the Nexus Network.

Through this manual we would like to help you install, operate and understand your new Nexus Network.

The Server is the "heart" of your Nexus Network, to which transducers for speed, depth, heading, wind and navigation (GPS, Loran or Decca) are connected.

From the Server the single Nexus Network cable transmits power and data to the instruments, which repeat the information sent from the Server, or other Nexus transducers.

The Nexus Network is designed with the industry standard RS 485 databus, which allows you to connect up to 32 Nexus instrument units on the single Nexus Network cable, thereby allowing you the flexibility to easily develop your system. The Nexus Network is capable of carrying data 10 times faster than NMEA 0183.

The connection system, with a single 5 mm (1/5") cable and 4-pole jack plugs with cable protectors, makes the installation easy. No need to drill big holes and the cable can be cut to exact lengths. The connections at the Server are colour coded and marked with a number for easy reference.

Nexus Multi Control is a multi function instrument that displays a main and a sub-function together. You can easily "customise" your favourite combination of functions, by using the unique method to move, copy and lock a sub-function.

The instruments large display gives you very good viewing possibilities from any angle, even in bright sunlight. The display and the four push-buttons have red back lighting which you can set to three different lighting levels.

A large selection of optional analogue repeaters and accessories are available. The analogue steer pilot instrument particularly offers unique functions. When used together with the steer reference function (AWA), you can actually steer after the wind and "expand" the tacking or down wind angle.

These Nexus instruments carry a two year warranty, which gives you as our customer, confidence to trust Nexus and our commitment to quality.

To get the most out of your new Nexus product, please read through this manual carefully before you start your installation.

INTRODUCTION

Again, thank you for choosing Nexus. If you see us at a show, stop by and say hello.

Good luck and happy boating!

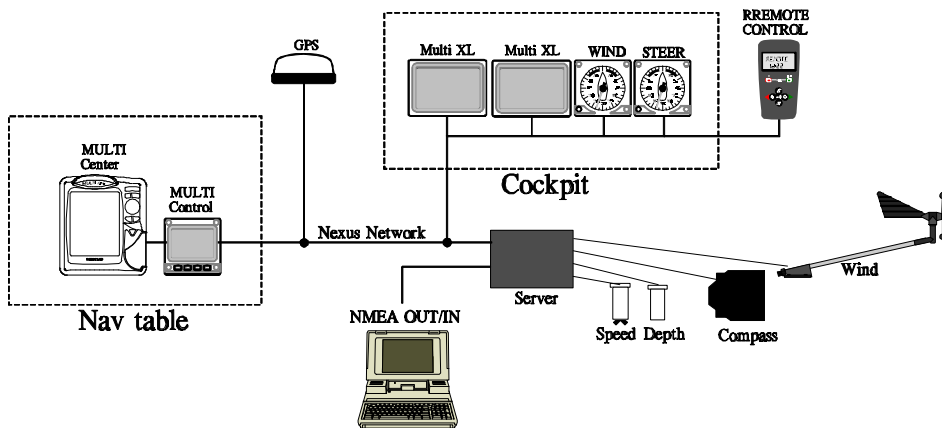

CONTENTS INSTALLATION

2.1 Location of the Server.....	11
2.2 Installing the Server.....	11
2.3 Location of the instrument	12
2.4 Installing the instrument	12
2.5 Installing the transducers.....	14
2.6 Connecting optional accessories.....	14
2.6.1 Man over board (MOB) push-button	14
2.6.2 Tactical function push-button.....	15
2.6.3 Extra alarm buzzer	15
2.6.4 Nexus instruments	15
2.6.5 Maxi repeater	16
2.7 Connecting instrument lighting.....	16
2.8 Connecting a NMEA instrument IN to the Server.....	16
2.9 Connecting a NMEA instrument OUT from Server.....	17
2.10 Connecting the power supply	17
2.11 Compatibility with our previous transducers	18
2.11.1 Log transducer	18
2.11.2 Depth transducer.....	19
2.11.3 Wind transducer.....	19
2.11.4 Compass transducer	20
2.11.5 GPS receiver.....	20
2.11.6 NMEA transducers	20

2 Installation

- **The installation includes 6 major steps:**
 1. Read the installation and operation manual.
 2. Plan where to install the transducers, Server and instruments.
 3. Install the transducers, then the Server and instruments.
 4. Run the cables.
 5. Take a break and admire your installation.
 6. Learn the functions and calibrate your system.

- **Before you begin drilling ...** think about how you can make the installation as neat and simple as your boat will allow. Plan where to position the transducers, Server and instruments. Think about leaving space for additional instruments in the future.

- **A few "do nots" you should consider:**
 - Do not cut the cables too short. Allow extra cable length at the Server so it can be disconnected for inspection without having to disconnect all attached cables.
 - Do not place sealant behind the display. The instrument gasket eliminates the need for sealant.
 - Do not run cables in the bilge, where water can appear.
 - Do not run cables close to fluorescent light sources, engine or radio transmitting equipment to avoid electrical disturbances.
 - Do not rush, take your time. A neat installation is easy to do.

- **The following material is needed:**
 - Wire cutters and strippers
 - Small and large philips and small flat head screw driver
 - Hole saw for the instrument clearance hole 50 mm (2")
 - 2.8 mm (0.11") drill for the mounting holes
 - Plastic cable ties



If the cable is not long enough, you can buy the optional Nexus 8 m (26 ft) extension cable (Art. No.21266-8), or use left over Nexus cable from other installations. The same 4-pole Nexus cable is used for all connections.

If you are doubtful about the installation, obtain the services of an experienced technician.

2.1 Location of the Server

The Server must be mounted on a dry, flat and vertical surface below deck, at least 500 mm (20") from radio receiving equipment.

Locate the Server in the centre of the boat and close to the electrical panel if possible.

2.2 Installing the Server

Remove the Server cover from the baseplate by removing the two screws. Drill the 4 screw holes using a 2.8 mm (0.11") drill. Mount the Server using the 4 mounting screws.

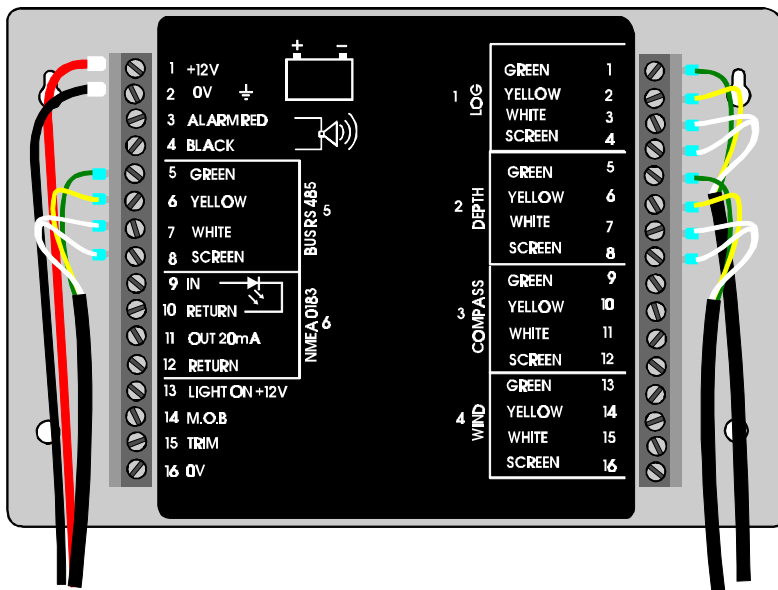

Apply silicon paste on the screw terminal. Connect the 8 m Nexus Network cable labelled number 5 and supplied with cable protectors to the Server on pins 5, 6, 7, and 8. Match the colour codes for each wire.

Note: If the cable must be cut, it is recommended it is cut at the un-marked cable end, since a marked cable is easier to identify.

When all connections are made, use the cable straps as required. Mount the Server cover using the 2 mounting screws.

Your Server installation is done!

2.3 Location of the instrument

The instrument is designed to be front mounted above or below deck. It should be mounted on a flat and smooth surface. This condition must be followed to ensure the gasket seals correctly against the mounting surface. Mount the instrument so that it:

- can be read by the helmsman / navigator,
- is satisfactorily protected from outer damage,
- is at least 500 mm (20") from radio receiving equipment,
- has sufficient clearance from behind, for the instrument housing and cables. The instrument can be mounted right next to a magnetic compass.

Note: On the reverse side, above the connection pins, the instrument has a small ventilation hole to avoid moisture gathering inside the instrument. The hole is protected by a ventilation membrane that allows air but not water to pass.

The instrument can be mounted on a mast bracket, provided enough silicon paste is applied to protect the connector.

2.4 Installing the instrument

Place the adhesive drill template on the desired location for the instrument. Drill the 4 screw holes using a 2,8 mm (0,11") drill. Use a 50 mm (2") hole saw to machine the clearance hole for the instrument connection socket. Remove the template.

Note: Never drill through the instruments 4 mounting holes as the gaskets may be damaged and thus cause leakage. The warranty is not valid for damage caused by drilling through the mounting holes.

- Run the Nexus Network cable from the Server to the instrument.
- Cut the Nexus Network cable to length. Peel off about 35 mm (1,4") of the cable insulation. Remove about 6 mm (1/4") from the 3 isolated wires (the 4:th wire is a earth / screen). Attach the 4 cable protectors to the wires using a pair of flat pliers.
- Connect the 4 cable protectors to the 4-pole jack plug as shown.
- Apply silicon paste on all locations as shown.

Note: Must be done to avoid corrosion.

INSTALLATION

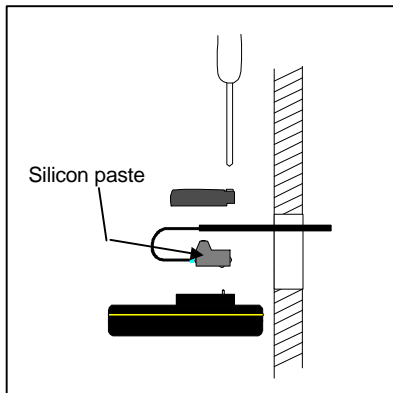
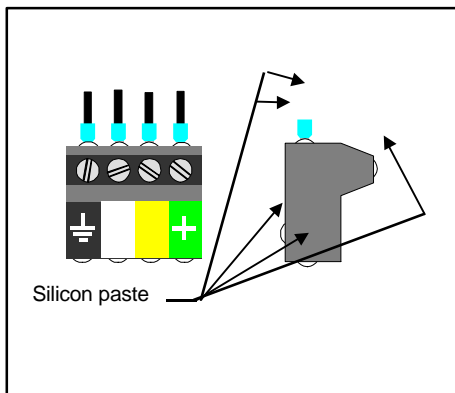
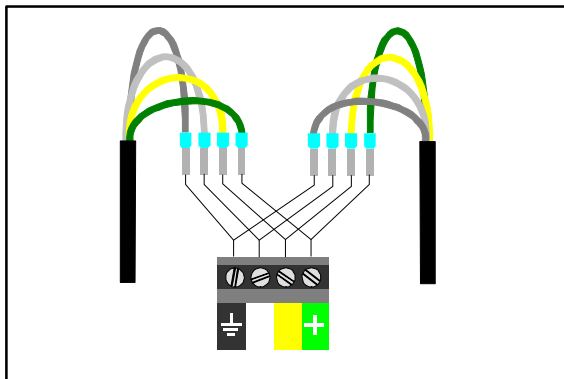

- Apply silicon paste to the instrument connection pins at the back of the instrument. Press the jack plug onto the instrument pins. Press down the cable in the cable leads. Mount the connection back cover with the 1 screw.
- Mount the instrument in the pre-drilled position.

Note! Use all 4 screws, and tighten the screws (in cross pattern) so the gasket will be evenly compressed to 1/3 of its original thickness.

Very important for a correct sealing to avoid leakage!

- Press on the 4 rubber caps to seal and hide the mounting screws.



Your instrument installation is done!

2.5 Installing the transducers

Log, depth, wind and compass transducers are all connected to the pins on the right hand side of the Server. They are all clearly colour coded and marked with numbers and names. Install the transducers according to the separate instructions supplied with each transducer. Connect as per below drawings

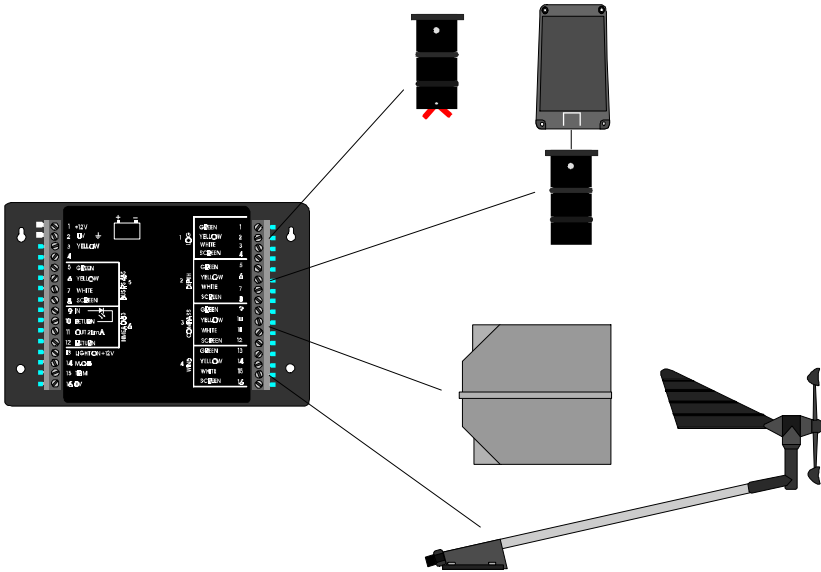

2.6 Connecting optional accessories

These optional accessories are available from your local Nexus Dealer. (For a more complete list of accessories available, see 14.4).

2.6.1 Man over board (MOB) push-button

Art. no. 19763. (For function explanation, see 10).

White wire to Server pin 14 (MOB). Brown wire to Server pin 16 (0V).

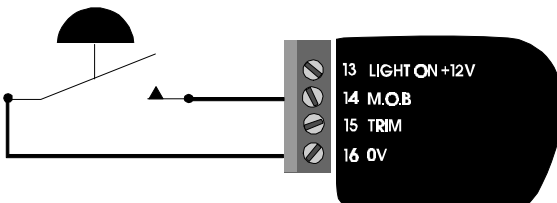

2.6.2 Tactical function push-button

Art. no. 19763 (same as MOB). (For function explanation, see 9.1).

White wire to Server pin 15 (TRIM). Brown wire to Server pin 16 (0 V).

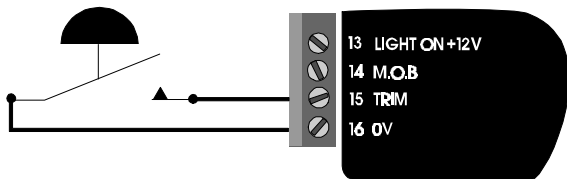

2.6.3 Extra alarm buzzer

Art. no. 20081. The extra buzzer (105 dB at 15 cm, not water proof) can be mounted where you want a louder sound. The buzzer will sound as soon as any alarm function is activated in the Nexus Network.

Red wire to Server pin 2 (ALARM RED).

Black wire to Server pin 4 (BLACK).

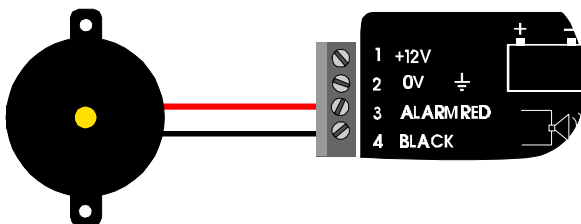

2.6.4 Nexus instruments

All Nexus instruments are connected directly to the Nexus Network in a daisy chain. They all use the same colour coded 4-pole jack plugs. (For instrument installation, see 2.2).

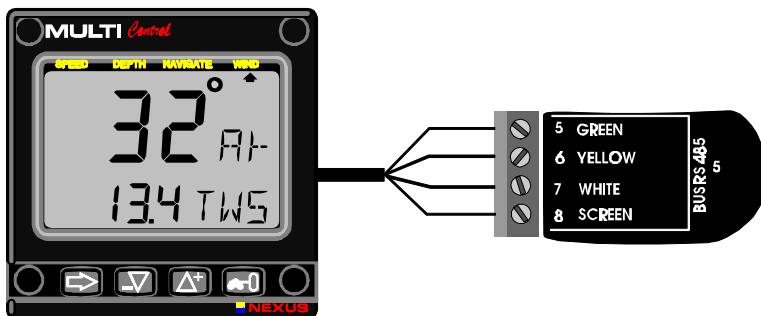

2.6.5 Maxi repeater

Electro mechanical Maxi repeaters with good readability and contrast, digit height: 45mm Red digits Art. no. 19941. Yellow digits Art. no. 19841. Up to 10 Maxi repeaters can be connected.

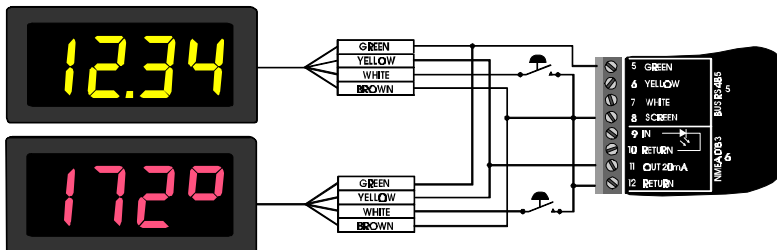

2.7 Connecting instrument lighting

The instrument lighting can be controlled from the boats general lighting switch.

Connect the wire from the electrical panels instrument light switch to Server pin 13 (LIGHT ON +12 V).

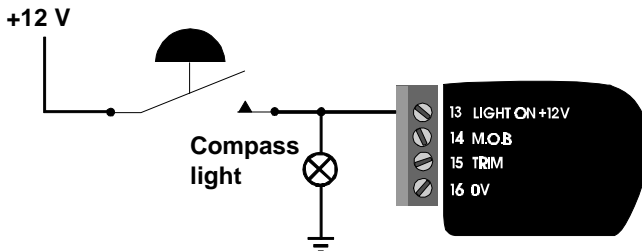

2.8 Connecting a NMEA instrument IN to the Server

Products transmitting NMEA, for example:

GPS, Decca, Loran, NMEA compass and wind transducer etc.

If a NMEA instrument is connected, most information will be available and can be displayed on the Nexus Network.

You must know which 2 cables from your other NMEA instrument carry the NMEA out signal. If you have trouble call the dealer you bought your NMEA instrument from. He should know the wiring colour and will probably sell the "plug set" which may be required. We do not have this information.

Connect NMEA out signal from the NMEA instrument to Server pin 9 (IN).

Connect NMEA return signal from the NMEA instrument to Server pin 10 (RETURN). (For list of NMEA receive sentences, see 12.6.3).

Note a: The Server allows only one NMEA instrument connected to the input pins 9 and 10.

Note b: We do not recommend the use of NMEA transducers like wind and compass, because the update rate of data is slow compared to the very fast Nexus data bus.

Note c: If the NMEA instrument has only one output cable, put a "bridge" cable on the Server between pins 10 (RETURN) and 12 (RETURN).(See chapter 12.6 , C75)

2.9 Connecting a NMEA instrument OUT from Server

Products receiving NMEA, for example:

Plotter, radar, Maxi repeaters, POWER Navigate.

Again you must know which 2 cables from your other NMEA instrument carry the NMEA in signal. If you have trouble call the dealer you bought the NMEA instrument from. He should know the wiring colour and will probably sell the "plug set" which may be required. We do not have this information.

Connect NMEA in signal from NMEA instrument to Server pin 11 (OUT). Connect NMEA return signal from NMEA instrument to Server pin 12 (RETURN). (For list of NMEA transmit sentences, see 12.61.)

2.10 Connecting the power supply

1. Connect the red wire from the Server pin 1 (+12V) to +12V.

Connect the black wire from the Server pin 2 (0V) to 0V.

Protect the circuit with a 3 Amp fuse/circuit breaker on the 12V side.

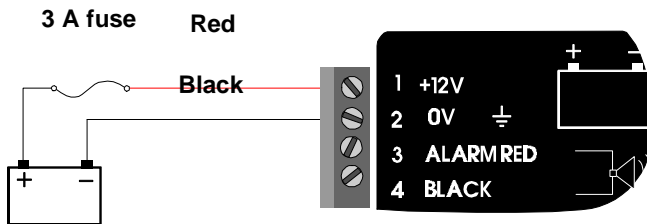

INSTALLATION

Note a: Try to keep the power cables as short as possible.

Note b: Up to 32 Nexus instrument units (Server, digital and analogue instruments, Autopilot servo-unit or a Nexus GPS) can be connected to the single Nexus data bus cable.

If more than 10 units are connected, the power must be supplied at both ends of the chain of units, a so called "ring-connection", as shown. Do not connect the Nexus data bus wires (yellow and white) in ring-connection.

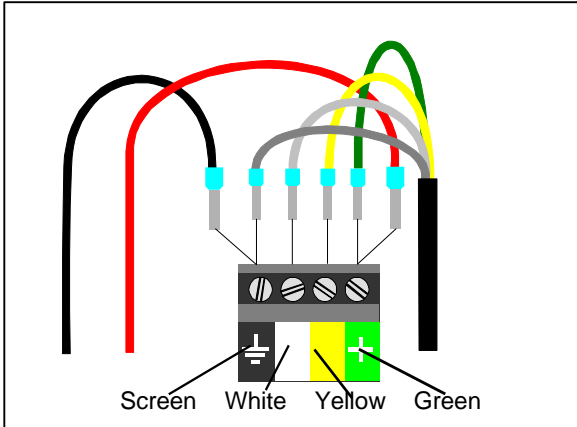

2. Check that all the connections are correct before you power up the system.

2.11 Compatibility with our previous transducers

2.11.1 Log transducer

All our log transducers (except the transducers from the S-2000 and S-200 series) can be used for speed and distance.

Only transducers from Nexus- and STAR-series are able to measure water temperature.

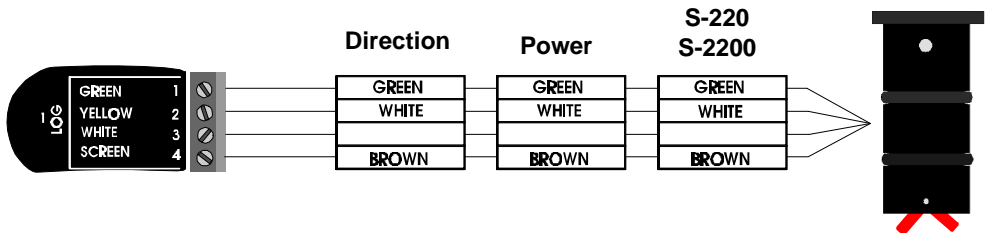

Note: On the Power transducer the white cable (for water temperature) should be isolated and not installed.

2.11.2 Depth transducer

Our depth transducers with stand alone amplifier boxes can be used, that is the Direction D30 and Power depth.

Note: Do not mix amplifier boxes with transducers from other series.

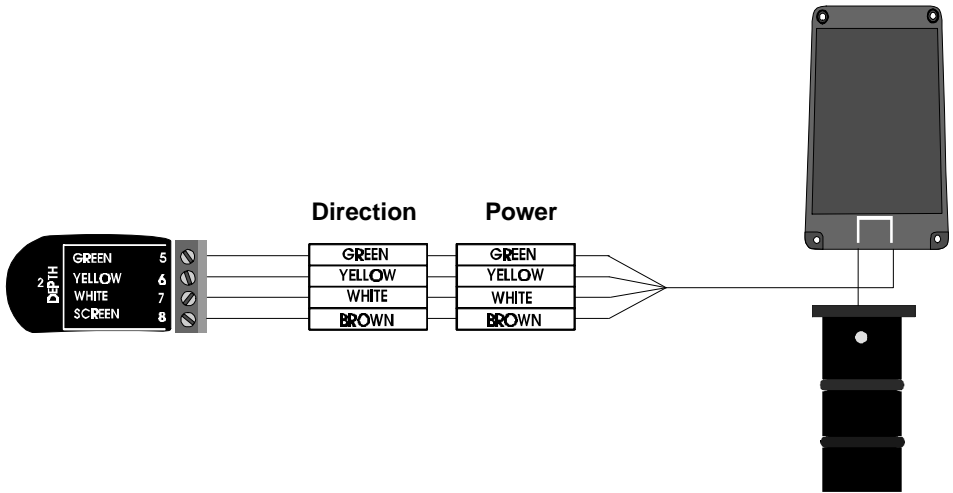

2.11.3 Wind transducer

All our wind transducers can be used.

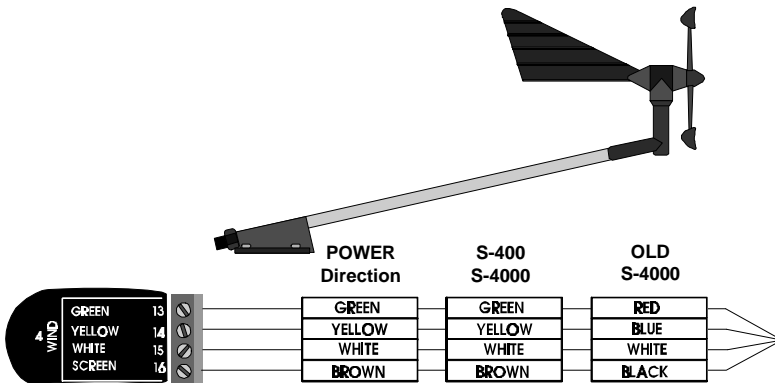

2.11.4 Compass transducer

Only the Nexus version can be used.

Compass transducer for S-5000, D50, S-520/S-525 and POWER can be upgraded to Nexus standard. Contact your local Nexus dealer for a quote.

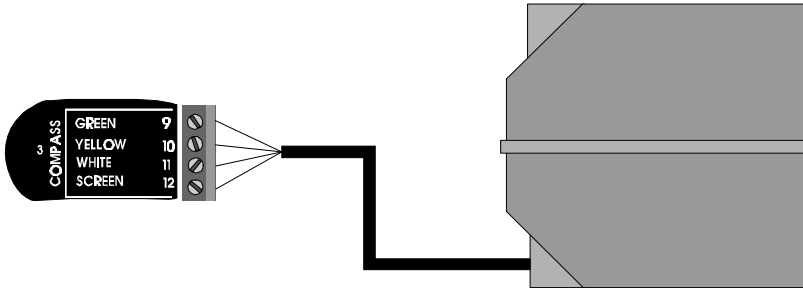

2.11.5 GPS receiver

All Nexus GPS products can be connected directly to the Nexus Network.

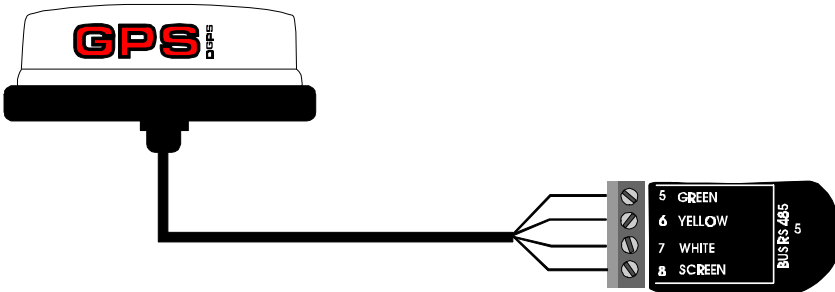

2.11.6 NMEA transducers

NMEA compass and NMEA wind transducer.

You must know which 2 cables from your other NMEA transducer carry the NMEA out signal. If you have trouble call the dealer you bought your NMEA instrument from. He should know the wiring colour and will probably sell the "plug set" which may be required. We do not have this information.

Connect NMEA out signal from the NMEA transducer to Server pin 9 (IN). Connect NMEA return signal from the NMEA transducer to Server pin 10 (RETURN).

Note a: The Server allows only one NMEA transducer or instrument connected to the input pins 9 and 10.

Note b: Make sure the calibration codes (C76 and C77 in chapter 12.6) for NMEA transducers are correctly set.

3 First start

3.1 Initialising the instrument

At power on, the instrument will perform a self test. The display will first show all segments, then the software version number and the Nexus Network ID number.



At first power on after installation, you will be asked to press **KEY** (PrESkey). This will give the instrument a logical ID number on the Nexus Network.



To initialise the instrument, press **KEY** on all installed digital instruments, one at the time.

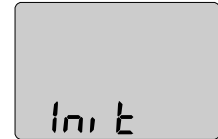

Note: Always wait for the text "Init OK" to be displayed, before you press KEY on the next instrument!



The Server automatically gives the first unit ID number 16, then 17 and so on. The order in which you press **KEY** is the same order as the instruments will be given a logical ID number on the Nexus Network.



The example shows that the instrument version number is 2.0 and the given logical ID number is 16.

3.2 Re-initializing the instrument

If two instruments by mistake have the same ID number, this can cause disturbance and block the information on the Nexus data bus.



To re-initialise the instrument, press **DOWN** and **UP** together during the power up sequence when version and ID numbers are displayed.



The display self test is then re-started on all instruments and you will be asked to press **KEY** on each instrument as explained above.

Note! If you do not succeed to re-initialise, we suggest you disconnect all but one instrument with the same ID number, then repeat the above procedure.

CONTENTS OPERATION

4.1 About this manual 23

4.2 How to use the 4 push-buttons 24

 4.2.1 MODE 24

 4.2.2 DOWN 24

 4.2.3 UP 24

 4.2.4 KEY 25

 4.2.5 Cancel / clear / reset 25

 4.2.6 Calibration 25

 4.2.7 Lighting 25

4 Operation

4.1 About this manual

- In this manual each time a push-button is referred to, the push-button name will appear in **bold** and CAPITAL letters example **MODE**.
- Unless otherwise stated the push-button presses are momentary.
- Each time a function is mentioned in the text, it will be in brackets and in the same format, where possible, as displayed, ex. (LAt).
- By the word navigator, we mean a GPS, Loran or Decca instrument.
- Which instrument is navigating? By the term navigating, we mean the active instrument in which the waypoint memory is used for navigation to calculate the navigation data, ie BTW, DTW etc. There can only be one instrument on the Nexus Network which is keeping the waypoints in memory, but the waypoints can be reached from all instruments.
- This manual has been written to be:
Compatible with Nexus Server from software version 2.6.
Compatible with Nexus Multi Control instrument from software version 2.3
The products can be updated to the latest version for a fee.
Please contact your Nexus dealer for further information.

4.2 How to use the push-buttons

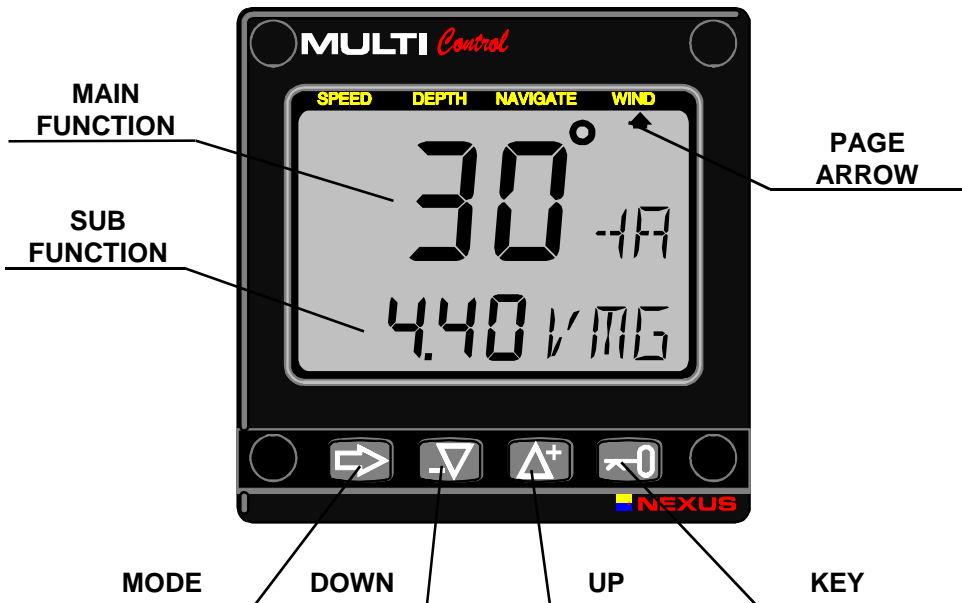

4.2.1 MODE

A press on **MODE** moves the top LCD arrow to the next page. It scrolls in a circular pattern, one step to the right for every press, in the order SPEED, DEPTH, NAVIGATE, WIND and then back to SPEED page again. A press on **MODE** and **DOWN together**, back steps MODE to the preceding page.



The **MODE** button is **also** used to move the cursor when in edit mode.

A press on **MODE** moves the cursor in a circular pattern, one step to the right for every press.

A press on **MODE** and **DOWN** together, back steps cursor to the preceding step.

4.2.2 DOWN

A press on **DOWN** moves to the next sub-function. In edit mode it decreases to the previous digit.



4.2.3 UP

A press on **UP** moves to the previous sub-function. In edit mode it increases to the next digit.



4.2.4 KEY

A press on **KEY** unlocks a digit to access edit mode. When unlocked, the digits are "active" (flashes) and can be edited by pressing **DOWN**, **UP** and **MODE** as required. When finished editing, lock the digit by another press on **KEY**.



4.2.5 Cancel / clear / reset

A press on **DOWN** and **UP together**, clear digits, cancel alarms or resets the counters.



4.2.6 Calibration

To access calibration mode, press and hold **KEY** more than 2 seconds.



To return to main-function mode, press **KEY** when the text return (RET) is shown.

4.2.7 Lighting

The instrument uses red back lighting for the display and the 4 push-buttons. The lighting can be set at 4 different levels.

To access the light control, press and hold **MODE** for more than 2 seconds. The flashing text (Lit OFF) will be displayed and the display will be lit momentarily.



To select between the 4 light levels, Press **UP**: LOW, MID, MAX and OFF. To lock the selected level press **KEY**.

The selected light level will be copied to all Nexus instruments connected to the system. When the lighting is on, it is not possible to reduce or turn off the lighting on an individual instrument.

5 Function overview

The functions in the Multi Control instrument are divided into 4 pages:

SPEED, DEPTH, NAVIGATE and WIND.

The selected page is indicated by the LCD arrow at top of the display.

Each page has 2 types of functions that can be displayed together:

1. Main-function, displayed at the top of the display in 24.4 mm (1")high digits.
2. Sub-function, displayed at the bottom part of the display in 13.6 mm (0.6") high digits.

You can easily customise your favourite combination of functions, (See 9).

The instrument can display metric and imperial units.

For unit selection, (see13).

For function overview and transducers needed to display each function, see the inside of the back cover.

In addition, the enclosed laminated quick guide will help you to get an overview when using the instrument onboard.

CONTENTS SPEED FUNCTIONS

6.1 SPEED main-function.....	28
6.2 SPEED sub-functions	28
6.2.1 TRIP LOG (TRP).....	28
6.2.2 TOTAL LOG (LOG).....	28
6.2.3 START TIMER (STA)	28
6.2.4 TIMER	28
6.2.5 DISTANCE (DST).....	28
6.2.6 AVERAGE SPEED (AVS).....	28
6.2.7 DAMPING (SEA).....	28
6.2.8 DEPTH (unit/DPT).....	29
6.2.9 (CMG) and (DMG).....	29
6.2.10 (BTW) and (DTW).....	29

6 SPEED functions

6.1 SPEED main-function

Boat speed through the water.

Unit available in knots (KT), km/h (Kh) or miles/h (Mh) (See 12.1.2,C11). If a navigator is connected, speed over ground (SOG) can be displayed. (See 12.1,C11 and C13).

6.2 SPEED sub-functions

6.2.1 TRIP LOG (TRP)

0-199,99 NM, only displayed in NM. Distance covered from power on.

To reset TRIP LOG press **DOWN** and **UP** together.

6.2.2 TOTAL LOG (LOG)

0-19999 NM, only displayed in NM. Can not be reset.

6.2.3 START TIMER (STA)

Count down timer from 10 and 5 minutes.

To start the timer from minus 10 minutes (-10'STA) press **KEY**.

To start the timer from minus 5 minutes (-5'STA), press **KEY** again.

When started, displays the count down time in minutes and seconds.

During the last 10 seconds the alarm will sound once every second.

6.2.4 TIMER

Elapsed time in hr/min/sec from power on, or from end of start timer count down. To reset, press **DOWN** and **UP** together.

6.2.5 DISTANCE (DST)

Covered distance from power on, or from reset of timer. To reset, press **DOWN** and **UP** together.

6.2.6 AVERAGE SPEED (AVS)

Average speed from power on, or from reset of timer. To reset press **DOWN** and **UP** together.

6.2.7 DAMPING (SEA)

Damping of indicated boat speed through the water. Controls the response time of speed changes.

To change damping, press **KEY**.

To select damping level, press **UP** and select from:

(**LOW**) 1 sec, (**MID**) 5 sec and (**MAX**) 22 sec.

To store the value, press **KEY**.

Default value is **(LOW)**, for use in calm sea. But if the sea is rough, you may want to "stabilise" the readout on the display, then select **(MID)** or **(MAX)**. Damping is set separately for each instrument.

6.2.8 DEPTH (unit/DPT)

Depth from the water surface or the keel depending on calibration setting (See 12.2.3, C22).

Unit available in meters (m), feet (FT) or fathoms (FA). (See 12.2.2,C21).

The text alternates between the selected (unit) and (DPT).

A rectangular digital display with a black background and white text. It shows the number "23" followed by a small "m" symbol.

6.2.9 (CMG) and (DMG)

Course made good (CMG) and distance made good (DMG)

The function is based on the principle of dead reckoning.

The function keeps track of the boats way through the water and displays course and distance in a straight line from the start position.

A rectangular digital display with a black background and white text. It shows the number "2790" followed by the text "CMG".

Locate and mark your position and reset CMG/DMG. Get underway.

To find your new position, plot the course and distance on your sea chart.

The function starts at power on.

To reset (CMG/DMG), press **DOWN** and **UP** together.

When the **MOB** button is pressed it temporarily resets the CMG/DMG function.

Alternating function. To stop alternating, press **KEY**.

To restart alternating, press **KEY** again.

6.2.10 (BTW) and (DTW)

Bearing to waypoint (BTW) and distance to waypoint (DTW):For function explanation, see drawing inside cover page.

To display this function, you must navigate towards a waypoint. (See 8.4 and 8.5).

Alternating function. To stop alternating, press **KEY**. To restart alternating, press **KEY** again.

A rectangular digital display with a black background and white text. It shows the number "2830" followed by the text "BTW".A rectangular digital display with a black background and white text. It shows the number "12.34" followed by the text "DTW".

CONTENTS DEPTH FUNCTIONS

7.1 DEPTH main-function.....	31
7.2 DEPTH sub-functions	31
7.2.1 SHALLOW ALARM (SHA)	31
7.2.2 DEPTH ALARM (DEA)	31
7.2.3 ANCHOR ALARM (ANC).....	31
7.2.4 TEMPERATURE (TMP).....	32
7.2.5 BATTERY (BAT)	32
7.2.6 BOAT SPEED (BSP/unit)	32
7.2.7 HEADING (HDT/HDM)	32
7.2.8 UNIVERSAL TIME (UTC)	32
7.2.9 TIME TO GO (TTG): Time to go in hr/min	32
7.3 Set and turn on shallow (SHA) and depth alarm (DEA)	33
7.4 Set and turn on anchor alarm (ANC).....	33
7.5 Clear an alarm value	33
7.6 Silencing an alarm.....	33
7.7 Turning off / on an alarm	33

7 Depth functions

General information

Alarm on = minute sign (´) displayed above the last depth digit in the sub-function.

Alarm off = no minute sign (´) displayed.

The alarms will be triggered, if the actual depth becomes less (shallow alarm), or more (depth alarm), than the set depth value.

The alarm is audible (signal) and visual (main and sub-function flashes).

When a triggered alarm has been silenced, it will only be triggered again if the selected depth value differs by +/-2m (6 ft)

If a different page than DEPTH is shown when the alarm is triggered, the set alarm function will automatically be shown flashing, until you silence or turn off the alarm. The instrument will then automatically return to the previous page.

Loss of signal. If there are no depth echoes for 3 seconds, the display indicates 3 dotted lines (---) until a new echo is received.

7.1 DEPTH main-function

Depth from the water surface or the keel depending on calibration setting (See 12.2.3, C22).

Unit available in meters (m), feet (FT) or fathoms (FA).
(See 12.2.2, C21).



7.2 DEPTH sub-functions

7.2.1 SHALLOW ALARM (SHA)

Depth at which point audible and visual alarms will be triggered, if the actual depth becomes less than the set value. (See 7.3).



7.2.2 DEPTH ALARM (DEA)

Depth at which point audible and visual alarms will be triggered, if the actual depth becomes more than the set value. (See 7.3).



7.2.3 ANCHOR ALARM (ANC)

When the anchor alarm is set, the instrument will first suggest a value for the shallow (SHA) alarm (actual depth minus 1,5 m / 5 FT) then a value for the depth (DEA) alarm (actual value plus 1.5 m / 5 FT).



DEPTH FUNCTIONS

You can either store the suggested values or set your own values. The logic is that when you are at anchor, the alarm will warn you if the boat is drifting towards deeper or shallower water. (See 7.4).

7.2.4 TEMPERATURE (TMP)

Water temperature. Units available in Celcius (C) or Fahrenheit (F). (See 12.3, C23 and C24)

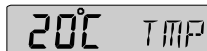
A rectangular digital display with a grey background and black text. It shows the number '20' followed by a degree symbol and the letters 'TMP'.

7.2.5 BATTERY (BAT)

Battery voltage at the Server.

A rectangular digital display with a grey background and black text. It shows the number '13.3' followed by the letters 'BAT'.

7.2.6 BOAT SPEED (BSP/unit)

Boat speed through the water. Select the unit from knots (KT), km/h (Kh) or miles/h (Mh). (See 12.1.2, C11). The text alternates between (BSP) and the selected (unit).

A rectangular digital display with a grey background and black text. It shows the number '6.05' followed by the letters 'BSP'.

7.2.7 HEADING (HDT/HDM)

Compass heading, heading true (HDT) or heading magnetic (HDM). (See 12.3, C32 and C47).

A rectangular digital display with a grey background and black text. It shows the number '270' followed by a degree symbol and the letters 'HDT'.

7.2.8 UNIVERSAL TIME (UTC)

Time in hr/min/sec. This function will only be displayed if a GPS receiver is connected to the system. The (UTC) is indicated by a (U) after the time.

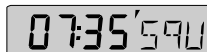
A rectangular digital display with a grey background and black text. It shows the time '07:35'59' followed by the letter 'U'.

To set your local time (L) zone from (UTC), press **KEY** and the first digit flashes.

If you want to add to (UTC), select underlining character (_).

If you want to reduce from (UTC), select minus sign (-) by pressing **UP**.

To set the time zone value press **MODE**, **DOWN** and **UP** as required.

To store the zone value press **KEY**.

Example: In United Kingdom the local time zone setting should be (_ 00h ZON) during winter time, and plus one hour (_01h ZON) in the summer time.

Note: Time zones of 0.5 hours can not be selected.

7.2.9 TIME TO GO (TTG): Time to go in hr/min

The function is based on actual speed towards next waypoint.

To display this function, you must navigate towards a waypoint. (See 8.4 and 8.5).

A rectangular digital display with a grey background and black text. It shows the time '13:42' followed by the letters 'TTG'.

7.3 Set and turn on shallow (SHA) and depth alarm (DEA)

Select shallow (SHA) or depth (DEA) alarm, press **KEY**.

The first digit in the previous value flashes.

If you want to reset the previous value to zero (0), Press **DOWN** and **UP** together.

To select desired depth press **DOWN**, **UP** and **MODE** as required.

Press **KEY** to lock the selected value.

By this last press on **KEY**, you have turned on the selected alarm function, which is indicated by the minute sign (´) above the last depth digit in the sub-function.

7.4 Set and turn on anchor alarm (ANC)

Select anchor alarm (ANC), press **KEY**.

The first digit flashes.

The instrument will suggest a value for the shallow (SHA) alarm (actual depth minus 1,5 m / 5 FT).

To store the value press **KEY**, or select your own depth as in 7.3.

The minute sign (´) is shown above the last depth digit in the sub-function.

The instrument will suggest a value for the depth (DEA) alarm (actual depth plus 1,5 m / 5 FT).

To store the value press **KEY**, or select your own depth as in 7.3.

The minute sign (´) is shown above the last depth digit in the sub-function.

7.5 Clear an alarm value

Select the alarm function to be cleared, press **KEY**.

The first digit flashes.

To clear the alarm, press **DOWN** and **UP** together. All digits are set to zero (0).

Press **KEY** to lock the function.

7.6 Silencing an alarm

To silence a triggered alarm that sounds and flashes, press **ANY** button.

The sound is silenced and the flashing stops.

The alarm is only triggered again if the selected depth value is exceeded (shallower or deeper) by 2 m (6 feet).

7.7 Turning off / on an alarm

Select the alarm function to be turned off / on.

To turn the alarm off / on, press **DOWN** and **UP** together.

The minute sign (´) disappears / appears.

CONTENTS NAVIGATION FUNCTIONS

8.1 NAVIGATION main-function	35
8.2 NAVIGATION sub-functions	35
8.2.1 STEER REFERENCE (Pilot OFF).....	35
8.2.2 STEER VALUE (STR)	35
8.2.3 DAMPING (SEA).....	35
8.2.4 (SOG) and (COG).....	35
8.2.5 (BTW) and (DTW).....	35
8.2.6 CROSS TRACK ERROR (XTE).....	35
8.2.7 EDIT WAYPOINT (Edit WP).....	36
8.2.8 GOTO WAYPOINT (Goto WP).....	36
8.2.9 LATITUDE and LONGITUDE (POS).....	36
8.2.10 SATELLITE STATUS (F:_ / SAT_).....	36
8.3 Steer reference (Pilot).....	36
8.3.1 Overview of steer reference (Pilot).....	37
8.3.2 Steer reference (MEM)	38
8.3.3 Steer reference (BTW)	38
8.3.4 Steer reference (CTS)	39
8.3.5 Steer reference (AWA)	39
8.4 Store and edit a waypoint (Edit WP)	40
8.4.1 Store present position.....	41
8.4.2 Edit a waypoint.....	41
8.4.3 Cancel a waypoint	42
8.5 Create a sailplan (Goto WP).....	42
8.5.1 Go to waypoint.....	43
8.5.2 Go to waypoint, from other than your present position	44
8.5.3 Cancel a leg in the sailplan.....	45
8.5.4 Insert a waypoint in the sailplan.....	45
8.6 Arrival alarm.....	46

8 NAVIGATION functions

8.1 NAVIGATION main-function

Heading 000° to 359°.

Heading true (HT) or heading magnetic (HM) can be displayed if the compass transducer is connected. (See 12.3, C32, C47).

If a navigator is connected, course over ground (CG) can be selected instead of compass heading. (See 12.3, C37).

270° HT

8.2 NAVIGATION sub-functions

8.2.1 STEER REFERENCE (Pilot OFF)

Displays the selected steer reference function. This function also controls what is shown on the optional analogue steer pilot instrument (Art No 20550-2). Steer reference can be selected from 5 alternatives. (See 8.3)

Pilot MEM

8.2.2 STEER VALUE (STR)

Displays steer value for the selected steer reference function(See 8.3).

280° STR

8.2.3 DAMPING (SEA)

Damping of compass heading.

Controls the response time of heading changes.

To change damping, press **KEY**.

To select damping level, press UP and select from:

(LOW) 1 sec, (MID) 5 sec and (MAX) 22 sec.

To store the selected value, press **KEY**.

Default value is (LOW), for use in calm sea. But if the sea is rough, you may want to "stabilise" the readout on the display, then select MID or (MAX). Damping is set separately for each instrument.

SEA LOW

8.2.4 (SOG) and (COG)

Speed over ground (SOG) and course over ground (COG).

Alternating function. To stop alternating, press **KEY**. To restart alternating, press **KEY** again.

5.60 SOG

035° COG

8.2.5 (BTW) and (DTW)

Bearing to waypoint (BTW) and distance to waypoint (DTW).

To display this function, you must navigate towards a waypoint. (See 8.2 and 8.3).

Alternating function. To stop alternating, press **KEY**. To restart alternating, press, **KEY** again.

283° BTW

283° BTW

8.2.6 CROSS TRACK ERROR (XTE)

Distance in nautical miles (NM) to desired track.

To display this function, you must navigate towards a waypoint. (See 8.4 and 8.5).

0.05 NM

0.11

Your boat is the "triangle" symbol and the desired track line is represented by the "3 vertical lines". The "triangle" symbol will tell you on which side of the desired track you are. You should aim to steer your boat so that the display readout is 0.00 NM, which means you are on the desired track.

8.2.7 EDIT WAYPOINT (Edit WP)

Edit and store waypoints. (See 8.4).

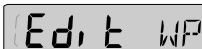

8.2.8 GOTO WAYPOINT (Goto WP)

Create a sail plan. (See 8.5).



8.2.9 LATITUDE and LONGITUDE (POS)

Displays position in selected format. Select format from degrees/minutes and 100:th of a minute (indicated by decimal (.) and minute (') signs) or from format degrees/minutes/seconds (indicated by minute (') sign only). (See 12.3.9, C38).

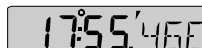

Alternating function.

To stop alternating, press **KEY**. To restart alternating, press **KEY** again.

8.2.10 SATELLITE STATUS (F: _ / SAT_)

Displays quality of reception and number of satellites (SAT) used. Example 4SAT = 4 satellites.

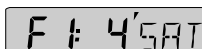

Figure of merit (F) is a factor for the GPS reception quality on a scale from 1 to 9 where F1 = best reception and F9 = no reception.

This function is only valid if a Nexus GPS receiver is connected to the Nexus Network.

8.3 Steer reference (Pilot)

The sub-function (Pilot) is intended to be used together with the optional analogue instrument steer pilot (Art. No. 20550-2) to assist the helmsman to keep the desired heading.

The powerful combination of the Multi Control instrument together with the analogue steer pilot actually offers you 6 functions.

Compass steering: (MEM)

1. Compass steering, using the 1 memory.
2. Headers and lifters, using the 2 memories and trim button. (See 9.1)

Wind steering: (AWA)

3. Close hauled indicator, ex. 35°
4. Down wind indicator, ex. 175°

Waypoint steering:

5. Bearing To waypoint (BTW)
6. Course To Steer (CTS), including set and drift

When a steer reference has been selected the analogue steer pilot instrument is immediately activated. It starts to indicate the difference between desired and actual heading or angle. The logic is to keep the steer pilot instrument needle straight up pointing at zero (0) to stay on the set heading.

From analogue steer pilot instrument version 2.0, (MEM) and (BTW) is functioning with COG (if navigator connected) even if a compass is not installed . The analogue read out will start at at speed above 4KTS and stop below 2 KTS.

If you do not have the analogue steer pilot instrument, you can still use the function, if you display the selected steer reference heading (STR) in the sub-function and compare it with the actual compass heading in the main-function.

A Nexus autopilot can not be activated from the steer reference function. But when the Nexus autopilot has been activated in compass or wind mode it is possible to alter the autopilots heading from the (MEM) and (AWA) functions.

The last used steer reference function will be stored in memory and automatically activated at power on. (Available Server version 2.6)

8.3.1 Overview of steer reference (Pilot

Steer reference function	Reference type	Text on display
(MEM) =Compass heading stored in 1 or 2 memories (TAC)	Manual	M E M
(BTW) =Bearing to waypoint	Automatic	W P
(CTS) =Course to steer to waypoint, corrected for drift and current	Automatic	M E M W P
(AWA) =Apparent wind angle	Manual	W I N D
(OFF) =Steer pilot off		

When any steer reference function is activated, the text on the display will be copied and shown on all Multi Control instruments in your Nexus Network.

8.3.2 Steer reference (MEM)



A rectangular display box with a light gray background and a thin black border. The text 'Pilot MEM' is displayed in a monospaced font. 'Pilot' is in a larger font size than 'MEM', and there is a small space between them.

This function requires the Nexus or NMEA compass transducer. The function is semi automatic, i.e. when activated, present compass heading is copied to memory. You can later change the value manually.

Select sub-function (Pilot), press **KEY**.

The text (OFF) or the last selected steer reference function flashes.

To select steer reference (MEM), press **UP**.

To activate the function, press **KEY**. MEM is shown on the display. The sub-function (STR) automatically displays the stored (MEM) value.

The text (MEM) and (STR) is alternating.

If you want to change the steer reference value, press **KEY**.

The first digit flashes.

To set the new value press **DOWN**, **UP** and **MODE** as required.

To store the value, press **KEY**.

Note: Steer reference heading value (MEM) can also be selected directly from the optional trim button, without first selecting (MEM) in (Pilot OFF) function. (Available from Server software version 1.9.)

8.3.3 Steer reference (BTW)



A rectangular display box with a light gray background and a thin black border. The text 'Pilot BTW' is displayed in a monospaced font. 'Pilot' is in a larger font size than 'BTW', and there is a small space between them.

This function requires the Nexus or NMEA compass transducer and a Nexus GPS or NMEA navigator.

When selected, the function displays (BTW) and the analogue steer pilot instrument displays the difference between the compass heading and the bearing to waypoint (BTW).

The function can only be displayed if the connected navigator is navigating towards a waypoint.

Since the displayed value it is controlled by the navigator, the value can not be altered.

Select sub-function (Pilot), press **KEY**.

The text (OFF) or the last selected steer reference function flashes.

To select steer reference (BTW), press **UP**.

To activate the function, press **KEY**. WP is shown on the display.

The sub-function (STR) automatically displays the stored (BTW) value.

8.3.4 Steer reference (CTS)

This function requires log transducer, Nexus or NMEA compass transducer, Nexus GPS or NMEA navigator.

When selected the function displays (CTS) and the analogue steer pilot instrument displays the difference between the compass heading and the bearing to waypoint (CTS) including set and drift.

The function can only be displayed if the connected navigator is navigating towards a waypoint.

Since the displayed value it is controlled by the navigator, the value can not be altered.

The function is compensated for set and drift, by using the parameters compass heading, boat speed through the water, course and speed over ground (COG/SOG) and bearing to waypoint (BTW).

Select sub-function (Pilot), press **KEY**.

The text (OFF) or the last selected steer reference function flashes.

To select steer reference (CTS), press UP.

To store the function, press **KEY**. MEM WP is lit on the display.

The sub-function (STR) automatically displays the stored (CTS) value.

The text (CTS) and (STR) is alternating.

The function is invaluable when you want to sail the shortest distance to a waypoint.

8.3.5 Steer reference (AWA)

This function requires the Nexus or NMEA wind transducer.

The function is semi automatic, i.e. when activated, present wind angle is copied to memory. You can also change the value manually.

The function displays the deviation from a set wind angle value and can be used as a "close hauled" tack indicator, or show an enlarged "picture" of the running angle.

Select sub-function (Pilot), press **KEY**.

The text (OFF) or the last selected steer reference function flashes.

To select steer reference (AWA), press **UP**.

To store the function, press **KEY**. WIND is shown on the display.

The sub-function (STR) automatically displays the stored (AWA) value.

The text (AWA) and (STR) is alternating.

If you want to change the steer reference value, press **KEY**.

The first digit flashes.

The underlining sign () = starboard side. The minus sign (-) = port side.

To select value, press **DOWN**, **UP** and **MODE** as required.

To store the value, press **KEY**.

When the steer reference function (AWA) is used together with the analogue steer pilot instrument, you can display an enlarged "picture" of the tacking or run angle. Put simply, you "expand" the wind angle.

Use the analogue steer pilot as a "close hauled" instrument.

Example: You have selected 35° starboard side (35° | - STR) as your tacking angle.

When the needle on the analogue steer pilot instrument points straight up to zero (0), you steer at the selected 35° wind angle.

You can of course also use the (AWA) function when running down wind, to keep a selected value for the run angle and/or to warn for a gybe.

Example: You have selected 160° port side (160° -| STR) as your running angle. When the needle on the analogue steer pilot instrument points to 15° port side you are at 145°. When the needle is at zero (0) you are at 160°. When the needle points 15° starboard you are at 175°.

At night, when you can not see the wind shifts, the use of the (AWA) function together with the analogue steer pilot is a very helpful.

This is a dynamite function that allows you to "expand" the wind angles!!!

When a Nexus Autopilot is activated in wind mode, the (AWA) function on the Multi Control instrument can be used to perform an automatic tack.

The minus sign (-) in front of the wind angle value = port side.

The underlining sign (_) in front of the wind angle value = starboard side.

Simply change the value of the digit in front of the wind angle, and the Nexus Autopilot will gibe to the opposite tack.

8.4 Store and edit a waypoint (Edit WP)

The Server contains a memory that stores up to 99 waypoints in a non-volatile memory.

Waypoint number 99 can be used as an ordinary waypoint, but if the MOB button is activated, this waypoint will be over-written by the MOB position.

Note: Which instrument is navigating? By the term navigating, we mean the active instrument in which the waypoint memory is used for navigation to calculate the navigation data, ie BTW, DTW etc. There can only be one instrument on the Nexus Network which is keeping the waypoints in memory, but the waypoints can be reached from all instruments.

- If a portable Nexus GPS is connected, the Server takes over the navigation.
- If a Nexus GPS Navigator instrument (art no 21032) and Antenna (art no 21000) is connected, the Nexus GPS Navigator instrument will take over the navigation when in Master mode. Through the configuration of this instrument, it can also be set to be a Nexus or NMEA repeater.
- If another NMEA navigator is connected, it depends on how the calibration code C75 is set. (See 12.6.6, C75).
C75 (OFF) = the Server is navigating.
C75 (ON) = the other NMEA navigator is navigating.

8.4.1 Store present position

Select sub-function (Edit WP) and press **KEY**.

The text (FREE), or the last stored or edited waypoint number will be displayed.

If the last waypoint is displayed, the latitude and longitude co-ordinates for the waypoint will be displayed alternating.

If required, press **UP** to select a (FREE) waypoint.

When a (FREE) waypoint is displayed, press **KEY** 3 times to store present position. Remember to note the waypoint number.

8.4.2 Edit a waypoint

Select sub-function (Edit WP), press **KEY**.

The last edited (Ed) waypoint number is displayed.

To select a (FREE) waypoint number, or to select a previous waypoint number to be edited, press **DOWN** or **UP**.

If you press and hold (more than 2 seconds) **DOWN** or **UP**, this press will decrease or increase the edit (Ed) waypoint number to the next 10:th digit.

To edit the selected waypoint, press **KEY**.

The actual or the last known latitude (LAt) from the navigator is displayed and the cursor for the first digit flashes.

To enter the new latitude co-ordinates and to select hemisphere North (N) or South (S), press **MODE**, **DOWN** and **UP** as required

To store the latitude, press **KEY**.

The actual or the last known longitude (Lon) from the navigator is displayed and the (°) and minute (´) sign flashes.

If the longitude is more than 99° East or West the cursor for the 100:th digit flashes. If the 100:th digit is not displayed, press **UP** to activate it.

To enter the new longitude co-ordinates, and to select hemisphere East (E) or West (W), press **MODE**, **DOWN** and **UP** as required. Press **KEY** to store the longitude.

The last edited (Ed) waypoint number is displayed together with the alternating latitude and longitude co-ordinates.

If you want to edit another waypoint number, press **DOWN** or **UP** to select the waypoint number, then press **KEY** and re-start the above procedure.

To exit from the function (Edit WP), press **MODE**.

The (Goto WP) function will be selected automatically. This is because it is most likely you would like to select one or more of the edited waypoints to be used for navigation in the (Goto WP) function sailplan.

To return to the function (Edit WP), press **UP**.

To create a sailplan (Goto WP), (see 8.5).

8.4.3 Cancel a waypoint

Select sub-function (Edit WP), press **KEY**.

The last edited (Ed) waypoint number is displayed.

To select the waypoint number to be cancelled, press **DOWN** or **UP**.

To cancel the waypoint, press **DOWN** and **UP** together.

The latitude and longitude co-ordinates will be replaced by the text (FREE).

To exit the function (Edit WP), press **MODE**.

8.5 Create a sailplan (Goto WP)

The Server contains a memory for 1 sailplan that can store up to 24 waypoints.

Each part of the sailplan is called a leg. A leg consists of 1 go from (Go FROM) waypoint and 1 go to next (Goto NXT) waypoint.

The sailplan is stored in a volatile memory, which means that the sailplan will be lost when the electrical power is cut. However the individual waypoints (01-99) remain in the (Edit WP) memory.

The procedure to create a sailplan is:

- Select the sub-function (Goto WP).
- Decide if you want to (Go FROM) present position (00) or from any another waypoint.
- Select a waypoint to (Goto NXT) in the first leg.
- Select waypoint for leg 2, leg 3 etc. up to the maximum 24 waypoints/legs.
- At the very moment, when the **KEY** is pressed in mode (Goto NXT), the Server will start the navigation and all navigation calculations will be displayed in the instrument.

Position to go from (Go FROM) is displayed as waypoint (00) when you navigate from your present position.

If you want to start navigation from any other waypoint (01 - 99), you can select that other waypoint number as your (Go FROM) position. The (Go FROM) position is mainly used to define your track line, to calculate XTE etc.

When the Nexus Network is set to be a repeater for an external NMEA navigator which is performing the navigation, you can display the waypoint in the (Goto WP) function, but you can not edit a waypoint other than in the NMEA navigator.

8.5.1 Go to waypoint

To use the function go to waypoint (Goto WP), at least one waypoint must first be stored in memory (Edit WP), (see 8.4.2).

Select the sub-function (Goto WP).

To create a sailplan, press **KEY**.

The function go to next (Goto NXT) is displayed and the small text (WP) flashes.

To unlock the waypoint, press **KEY**.

The first digit of the last "active" waypoint flashes.

To select a waypoint, press **DOWN**, **UP** and **MODE** as required.

To store the value, press **KEY**.

Note: At this very moment, when the KEY is pressed, the Server will start navigation calculation based on your stored waypoint and the navigation data will be available on the Nexus Network.

Bearing (123°) and distance (12.34) NM for the first leg (*01), from current position (00) to the waypoint (01) is displayed on the instrument.

Note: Always check with your sea chart that the bearing and distance is correct before you continue with the next leg.

If there is a difference, check that the co-ordinates in function (Edit WP) are correct.

To add waypoints/legs to the sailplan, press **UP** to display (Goto NXT).

To unlock and add waypoints/legs, press **KEY** and repeat the above described process.

To exit the (Goto WP) function, press **MODE**.

When you arrive at a waypoint in the sailplan, a series of automatic actions take place:

- The audible and visual arrival alarm is triggered. (See 8.6).
- The next waypoint in the sailplan (Goto NXT) will be activated as the new (Goto WP).
- The arrival waypoint is changed into the (Go From) waypoint.
- The previous (Go From) waypoint is cancelled from the sailplan.

When you have arrived at your last waypoint in the sailplan, the last waypoint will remain in memory (displayed as (Goto) and no.) and the sailplan will remain "active" (still calculating navigation data), until the power is cut.

If you want to cancel the last waypoint from the sailplan memory and thereby stop the navigation, press **DOWN** and **UP** together, when (Goto) and no. is displayed.

After that, (Goto WP) will be displayed, which confirms the sailplan is empty.

8.5.2 Go to waypoint, from other than your present position

Position to go from (Go FROM) is displayed as waypoint (00) when you navigate from your present position.

If you want to start navigation from any other waypoint (01 - 99), you can select that other waypoint number as your (Go FROM) position.

To start navigation **from** any other waypoint than the present position (00), example: (Go FROM) waypoint number (05) to (Goto NXT) number (06).

Select sub-function (Goto WP), and press **KEY**.

To select the function (Go FROM), press **DOWN** until (Go FROM) is displayed.

To change function (Go FROM) from present position (00) to waypoint number (05), press **KEY**.

The first digit flashes.

To change from (00) to (05), press **MODE** and **UP** until 5 is displayed.

To store the value, press **KEY**.

To start navigation to waypoint number (06), continue from above example and press **UP** until (Goto NXT) is displayed.

To unlock the value, press **KEY**.

To change from waypoint number (05) to (06), press **UP**.

To store the new value, press **KEY**.

From waypoint (05) to (06) the bearing is 345° and the distance 33.45 NM. It is also indicated that this is the first leg (*01).

The cross track error (XTE) function will be calculated with respect to this new bearing and not as if the starting position was the present position (00).

8.5.3 Cancel a leg in the sailplan

If the sub-function displays (Goto WP), it confirms the sailplan is empty, that means that no waypoints are stored in it.

If the sub-function displays (Goto) and a number, example (Goto 3), it confirms the sailplan is "active" (at least one waypoint is stored in it), and that the Server is actually calculating navigation data towards the displayed "active" waypoint.

Select sub-function (Goto 3), press **KEY**.

To select the leg you want to cancel, press **DOWN** or **UP**.

To cancel the selected waypoint, press **DOWN** and **UP** together.

The next leg in the sail plan is displayed.

To exit from the function, press **MODE**.

8.5.4 Insert a waypoint in the sailplan

The function insert (In-SErt) allows you to rearrange the sailplan if you want to insert or cancel a waypoint.

Example: Enter any 4 waypoints (Edit WP) , (see 8.4.2), and store them in sailplan (Goto WP), (see 8.5.1), in the following leg order:

Leg (*1) Go FROM (00) Goto NXT (01)

Leg (*2) Go FROM (01) Goto NXT (02)

Leg (*3) Go FROM (02) Goto NXT (03)

Leg (*4) Go FROM (03) Goto NXT (04)

Let us say that you change your plans and would like to go from waypoint (02) direct to waypoint (04), that is to insert waypoint (04) before leg (*3).

Since you are still in the dock and have not started your trip, the display will indicate (Goto 1), based on above sailplan.

Select sub-function (Goto 1), press **KEY**.

To select leg (*3), press **DOWN**, 2 times.

To insert the waypoint before leg (*3), press **UP** and **KEY** together.

The text (In-SErt) will be displayed with the previous Goto **NXT** waypoint flashing.

To select waypoint number (04), press **MODE** then **UP** 1 time.

To store the inserted waypoint (04), press **KEY**.

Bearing and distance from the previous waypoint (02) to the inserted waypoint (04) will be displayed as the new leg *(3).

To exit from the function, press **MODE**.

The new sail plan will look like this:

Leg (*1) Go FROM (00) Goto **NXT** (01)

Leg (*2) Go FROM (01) Goto **NXT** (02)

Leg (*3) Go FROM (02) Goto **NXT (04)**

Leg (*4) Go FROM (04) Goto **NXT** (03)

Leg (*5) Go FROM (03) Goto **NXT** (04)

The last inserted waypoint will move down all the following waypoints one step in the sailplan. If the sailplan is already contains 24 waypoints (full), and you add or insert a new waypoint, the 24:th waypoint will be automatically cancelled from the sailplan.

8.6 Arrival alarm

If the function (Goto WP) has been activated, the audible and visual arrival alarm is triggered automatically, when the boat arrives within a selected radius from the (Goto WP) waypoint. Factory setting radius value is 0.10 nautical mile. (See 12.3.12, C41).

When the audible alarm is triggered (beeps 3 times), the text (ArriVAL) flashes 3 times on all connected Multi Control instruments. After the arrival alarm the instrument will revert to the previous displayed function.

To turn off arrival alarm set C41 to (0.00 ARC). (See 12.3.12).

CONTENTS WIND FUNCTIONS

9.1 WIND Main-function	48
9.2 WIND Sub-functions.....	48
9.2.1 APPARENT WIND SPEED (AWS)	48
9.2.2 DAMPING (SEA).....	49
9.2.3 TRUE WIND SPEED TWS	49
9.2.4 GEOGRAPHIC WIND DIRECTION	49
9.2.5 VELOCITY MADE GOOD (VMG)	50
9.2.6 TACTICAL FUNCTION (TAC).....	50
9.2.7 WAYPOINT CLOSURE VELOCITY (WCV)	50
9.2.8 SET and DRIFT.....	50
9.2.9 ROLL (Roll).....	50
9.3 Tactical function	50

9 Wind functions

9.1 WIND Main-function

Apparent wind angle (AWA), true wind angle (TWA) 000° - 359°, apparent wind speed (AWS) or true wind speed (TWS):



The main-function WIND, allows you to display wind angle or wind speed, true or apparent. The wind angle is indicated by a symbol to the right of the wind angle value:

$\overline{\text{A}}$ = Wind from port side.

A = Wind from starboard side.

The type of wind true or apparent, is indicated by a letter:

$\overline{\text{A}}$ = Apparent wind .

A = True wind.

The selection of apparent (AWA) or true (TWA) wind angle in the main function also controls what is displayed on the optional analogue wind instrument (art. no 20550-1).

When the instrument is delivered, the factory setting for the main function is apparent wind angle (AWA). (See 12.5, C51 and C63).

9.2 WIND Sub-functions

9.2.1 APPARENT WIND SPEED (AWS)

Units displayed in m/s (m/s), knots (KTS) or Beaufort (BF), (see 12.5, C52). The function alternates between (AWS) and the selected (units).



9.2.2 TRUE WIND ANGLE (TWA)

This function requires a log transducer. The complimenting function to what is displayed in the main function is displayed.



If the main function is set to display apparent wind angle (AWA), the true wind angle (TWA) will be displayed here.

If the main-function is set to display true wind angle (TWA), the apparent wind angle (AWA) will be displayed here.

If the main-function is set to display apparent wind speed (AWS), apparent wind angle (AWA) will be displayed here.

If the main-function is set to display true wind speed (TWS), true wind angle (TWA) will be displayed here.

9.2.2 DAMPING (SEA)

Damping of wind information. Controls the response time of wind changes. To change damping, press **KEY**. To select damping level, press **UP** and select from: LOW) 1 sec, (MID) 5 sec and (MAX) 22 sec. To store the selected value, press **KEY**.

Factory value is (LOW), for use in calm sea. But if the sea is rough, you may want to "stabilise" the readout on the display, then select MID or (MAX). Damping is set separately for each instrument.



9.2.3 TRUE WIND SPEED TWS

This function requires a log transducer. Displayed in m/s (m/s), knots (KTS) or Beaufort (BF). (See 12.5, C52). The text alternates between (TWS) and the selected (unit)

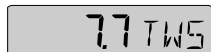

9.2.4 GEOGRAPHIC WIND DIRECTION

This function requires a compass transducer. Displays the direction in 000° to 359° and the each cardinal point abbreviation as shown:



- 000.0° = N
- 022.5° = NNE
- 045.0° = NE
- 067.5° = ENE
- 090.0° = E
- 112.5° = ESE
- 135.0° = SE
- 157.5° = SSE
- 180.0° = S
- 202.5° = SSW
- 225.0° = SW
- 247.5° = WSW
- 270.0° = W
- 292.5° = WNW
- 315.0° = NW
- 337.5° = NNW

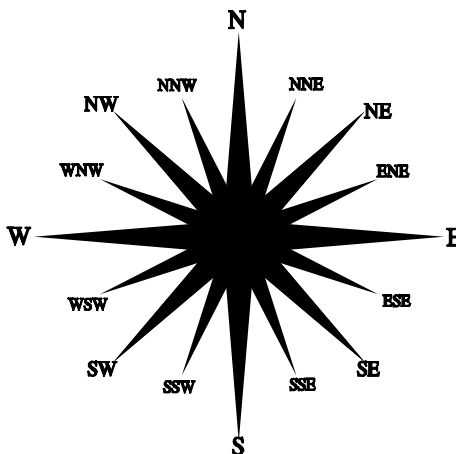

If magnetic heading is selected, geographic wind direction will also be magnetic direction. (See 12.4, C32 and C47)

9.2.5 VELOCITY MADE GOOD (VMG)

Displays speed into the wind or speed running with the wind in (KTS), (Km) or (Mh), (see 12.1.2, C11). See drawing.

The text alternates between (VMG) and the selected (unit).

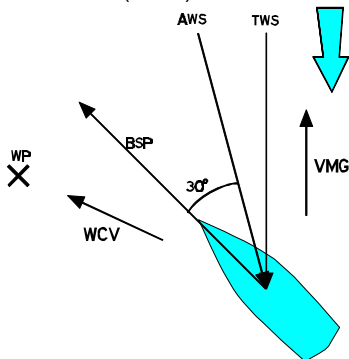

9.2.6 TACTICAL FUNCTION (TAC)

Displays heading memory, one for starboard and one for port tack. (For function explanation, see 9.3).



9.2.7 WAYPOINT CLOSURE VELOCITY (WCV)

Displays the speed over ground towards the waypoint in (KTS), (Km) or (Mh), (see 12.1.2, C11).

The text alternates between (WCV) and the selected (unit).



9.2.8 SET and DRIFT

Direction of current (SET) and speed of current (DRF).

Alternating function. To stop alternating, press KEY.

To restart alternating, press KEY again.



9.2.9 ROLL (Roll)

The heeling angle of the boat.

= heeling to starboard side.

= heeling to port side.

The Server will compensate the wind angle and the wind speed errors due to heeling.

The compensation is already implemented in the Nexus Network, but a transducer to indicate roll is not yet available.

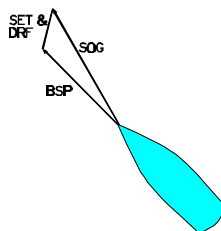

9.3 Tactical function

This function requires a compass transducer and displays course memory. One for starboard and one for port tack.

To fully use the tactical function it is recommended to install the optional trim button (Art. No. 19763) and analogue steer pilot instrument (Art. No 20550-2). The trim button is usually installed close to the steering position. Many prefer to install one trim button on each side of the boat, that is one for each tack. (For installation of trim button, see 2.4.2). Your apparent tack angle is assumed to be constant, in that your magnetic heading will be

changed compared to the wind, that is you will be changing your heading due to the wind shifts.

The tactical function will give you a fast and exact information about any wind shift compared to the magnetic heading.

EXAMPLE NEXUS "TAC" FUNCTION

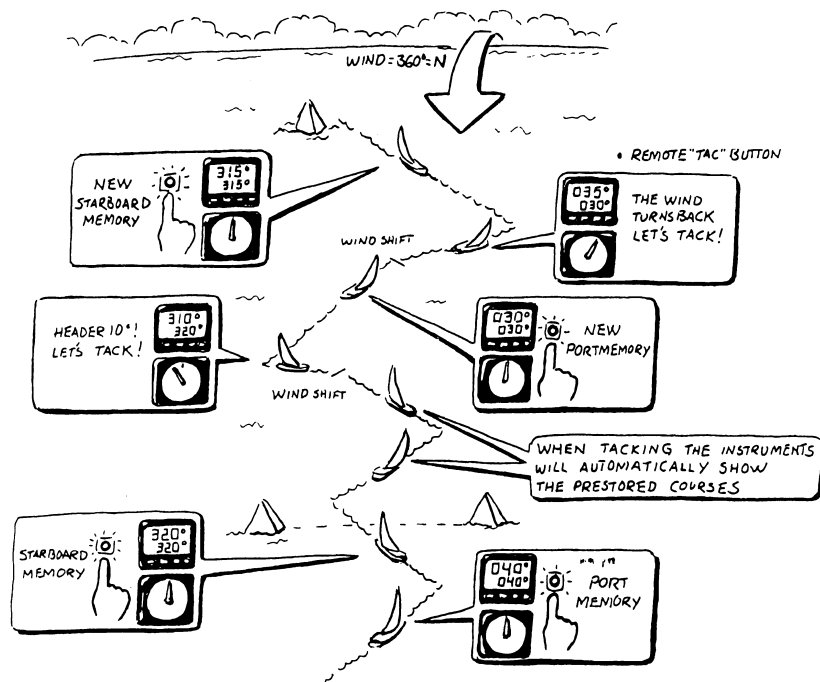

Select sub-function (TAC).

When you have maximum "lift", press **KEY** (or the trim button) to store the value. When the wind "heads" more than 5-10° it is time to tack.

Follow the same procedure on the new leg. The reference value for the selected tack, will be changed every time you press **KEY** (or the trim button). When you tack, the reference value of the last leg will automatically be displayed.

If the optional analogue steer pilot instrument connected, select sub-function pilot (MEM), as steer reference (See 8.3).

The deviation from selected course will be displayed on the analogue steer pilot instrument.

If you do not have the optional trim button or analogue steer pilot connected, we suggest you move the sub-function (TAC) to the NAVIGATE page. Now you can display both the heading and the tactical reference (TAC) at the same time.

Remember to turn off the off course alarm. To turn off the off course alarm, set C31 to (00*), (See 12.3.2, C31).

10 Man over board (MOB) function



This function will guide you back to the position where the man over board (MOB) button was pressed.

This function requires either a navigator (a Nexus GPS or NMEA navigator can be used as long as the Server is set to perform the navigation, see 12.6, C75), or a speed and compass transducer as well as a man over board (MOB) button. (See 2.4.1).

If only a compass and a speed transducer is connected, dead reckoning (MOB) will be displayed on both the Multi Control and the SPEED Log instruments. Dead reckoning (MOB) is also a very useful information, since a person in the water will drift almost as fast as the boat.

If a navigator, a compass and a log transducer is connected, dead reckoning (MOB) will be performed and displayed in the SPEED Log instrument. At the same time the Multi Control instrument will display (MOB) relative position stored in memory when the (MOB) button was activated. A position in latitude and longitude is more important for the sea rescue service.

The (MOB) position is automatically stored in waypoint number 99, and over writes any earlier stored position.

To activate the MOB function, press the (MOB) button.

A fixed alarm signal will sound briefly to alert the crew. The text (MOB) flashes.

Off course error will be displayed in the main-function.

┌- = steer to starboard. -┘ = steer to port.

Distance to the MOB position will be displayed in the sub-function. All you have to do is to keep calm and steer the boat in the indicated direction and distance to pick up your wet crew member. To reset the (MOB) function, press **DOWN** and **UP** together.

The earlier calculated course (CMG) and the distance made good (DMG) is not affected by the (MOB) function.

If a Nexus GPS and the analogue steer pilot instrument is connected the analogue instrument will indicate (MOB) course difference with priority to GPS position over dead reckoning position.

Note: It is wise to practice this manoeuvre with the crew. Everyone in the crew should be aware of the (MOB) routine. When you practice, it can be thoughtful to use a fender instead of a crew member!!!

11 Customise your display

All sub-functions are organised in a list under the main-function. The first location in the sub-function list is an empty display. You can have your favourite sub-function moved in the same sub-function list, or copied and locked to any other page.

11.1 Move and lock a sub-function

Example: In SPEED page, move and lock the sub-function depth (DPT) to the top of the sub-function list.

Select the SPEED page and find the sub-function depth (DPT). Press **MODE** and **KEY** together.

All digits flash.

To move and lock the sub-function press **KEY**.

Each time the SPEED page is selected, the sub-function (DPT) will be displayed at the top of the sub-function list.

11.2 Copy and lock a sub-function

Example: Copy and lock the sub-function true wind speed (TWS) from WIND page to SPEED page.

Select WIND page and find the sub-function (TWS).

Press **MODE** and **KEY** together.

All digits flash.

To move and copy to SPEED page, press **MODE**.

To lock the function, press **KEY**.

Each time the SPEED page is selected, the sub-function (TWS) will be displayed.

The copied sub-function remains in its original location. It is only copied to a second location, where it takes the place of the empty sub-function in the list.

Note: The sub-function damping (SEA) should not be moved, to avoid misunderstanding.

11.3 Select power on function

The last selected combination of page and sub-functions according to your selection in 11.1 is the first page the instrument will display at power up.

11.4 Cancel a moved or locked sub-function

Example: To cancel the previous moved sub-function true wind speed (TWS) from SPEED page.

Select the new combination, SPEED page and sub-function (TWS).

Press **MODE** and **KEY** together.

All digits flash.

To cancel the moved sub-function, press **DOWN** and **UP** together.

The sub-function is cancelled and the main-function still flashes.

To return the to the original display, press **KEY**.

11.5 Temporary locking of alternating functions

Some functions will alternate automatically between two functions.

Example bearing to waypoint (BTW) and distance to waypoint (DTW).

To stop alternating, press **KEY**.

To continue alternating, press **KEY** again.

CONTENTS CALIBRATION

12.1 Calibration of speed C10	57
12.1.1 C10 Return (RET)	57
12.1.2 C11 (Unit KTS).....	57
12.1.3 C12 (1.25 CAL)	57
12.1.4 C13 (OFF SOG).....	58
12.2 C20, calibration of depth.....	58
12.2.1 C20 (RET).....	58
12.2.2 C21 (Unit m)	58
12.2.3 C22 (- 00.0 ADJ)	58
12.2.4 C23 (Unit°C)	58
12.2.5 C24 (0°C TMP).....	58
12.3 C30, calibration of navigation	58
12.3.1 C30 (RET).....	58
12.3.2 C31 (00° OCA).....	58
12.3.3 C32 (00.0 VAR).....	59
12.3.4 C33 (Auto DEV)	59
12.3.5 C34 (Auto CHK)	59
12.3.6 12.3.6 C35 (Auto CLR).....	59
12.3.7 12.3.7 C36 (000°ADJ)	59
12.3.8 C37 (OFF COG).....	59
12.3.9 C38 (OFF SEC).....	59
12.3.10 12.3.10 C39 (0.00 LAT)	59
12.3.11 12.3.11 C40 (0.00 LON)	59
12.3.12 C41 (0.10 ARC).....	60
12.3.13 C42 (RDR). C43 (AP1). C44 (AP2)	60
12.3.14 C45 (Pilot SEA).....	60
12.3.15 C46 (000 LGD).....	60
12.3.16 C47 (OFF MAG).....	60
12.4 Compass calibration	60
12.4.1 Automatic compass deviation compensation (Auto DEV).....	60
12.4.2 Automatic compass deviation check (Auto CHK)	61
12.4.3 Cancel earlier performed compass deviation (Auto CLR)	61
12.4.4 Compass misalignment correction (Adj)	61
12.5 C50, calibration of wind	62
12.5.1 C50 (RET).....	62
12.5.2 C37 (OFF COG).....	62
12.5.3 C51 (OFF TWA).....	62
12.5.4 C52 (Unit m/s).....	62
12.5.5 C53 (1.50 CAL)	62
12.5.6 C54 (000° ADJ).....	62
12.5.7 C55-C62 Wind calibration values	62
12.5.8 C63 (WIA).....	63

12.6 C70, calibration of Network and NMEA	63
12.6.1 C70 (RET).....	63
12.6.2 C71 (On KEY).....	63
12.6.3 C72 (d0 SEA).....	63
12.6.4 C73 (OFF WPR)	64
12.6.5 C74 (On WPT)	64
12.6.6 C75 (OFF NAV).....	64
12.6.7 C76 (OFF CMP)	64
12.6.8 C77 (OFF WIND)	64
12.6.9 C78 (00 WBN)	64
12.6.10 C79 to C94.....	65
12.6.11 12.6.11 C95 (d4 NME).....	65
12.7 NMEA.....	65
12.7.1 Transmit NMEA sentences OUT from Server.....	65
12.7.2 Change NMEA sentences OUT from Server.....	67
12.7.3 Receive NMEA sentences IN to Server	68
12.8 Special NMEA sentences.....	69

12 Calibration

To get the most out of your Nexus Network, it is important to carefully calibrate the Network. The calibration values are stored in a non volatile memory.

To access calibration mode, press and hold **KEY** more than 2 seconds.

To select a calibration code, press **DOWN, UP** and **MODE** as required.

To return to normal mode, press **KEY** when the text return (RET) is displayed.

The different calibration routines are divided into five groups:

C10 - calibration of SPEED

C20 - calibration of DEPTH

C30 - calibration of NAVIGATE

C50 - calibration of WIND

C70 - calibration of Network and NMEA settings

To change a calibration value, press **KEY**.

To select calibration value, press **DOWN, UP** and **MODE** as required.

To lock the selected value, press **KEY**

12.1 Calibration of speed C10

12.1.1 C10 Return (RET)

To return to normal mode, press **KEY**.

12.1.2 C11 (Unit KTS)

Unit for speed. Knots (KTS), km/h (K/h) or miles/h (m/h).

12.1.3 C12 (1.25 CAL)

Calibration value for speed and distance (1.00 - 1.99).

Drive the boat a measured distance at normal speed.

Compare the distance with the trip counter.

Calculate the value with the following formula:

True distance from the sea chart :	T
Log trip counter distance:	L
The current calibration value:	C
New calibration value.	N

$$\frac{T}{L} \times C = N$$

If you suspect a current in the water, drive the boat in both directions and divide trip counter distance by 2.

12.1.4 C13 (OFF SOG)

Select speed transducer to be displayed as main-function under SPEED.

(OFF) = Boat speed through the water from log transducer.

(ON) = Speed Over Ground (SOG) from navigator.

12.2 C20, calibration of depth

12.2.1 C20 (RET)

To return to normal mode, press **KEY**.

12.2.2 C21 (Unit m)

Unit for depth. Metre (m), feet (Ft) or fathoms (FA).

12.2.3 C22 (- 00.0 ADJ)

Calibration of the depth transducer position.

This option is used to select whether the displayed water depth is measured from the water level or the keel.

To measure from the keel, use the minus (-) sign.

Example: (- 01.2 ADJ). The distance from the transducer to the keel is 1.2 m

To measure from the water surface, use the underlining character (_) sign.

Example: (_ 00.4 ADJ). The distance from the transducer to the water surface is 0.4 m.

The selected value will be subtracted or added from the measured depth.

12.2.4 C23 (Unit°C)

Unit for temperature. Celsius (C) or Fahrenheit (F).

12.2.5 C24 (0°C TMP)

Value for compensation of the temperature.

To add, use underlining character (_) ahead of the digit (_1 TMP).

To subtract, use minus character (-) ahead of the digit (-1 TMP).

12.3 C30, calibration of navigation

12.3.1 C30 (RET)

To return to the normal mode, press **KEY**.

12.3.2 C31 (00° OCA)

Off Course Alarm. Can be set between 00° and 99°

(00°) = Alarm is turned off.

12.3.3 C32 (00.0 VAR)

Magnetic variation. Maximum +/- 99.9°.

Easterly variation = underlining (_) sign.

Westerly variation = minus (-) sign.

The local magnetic variation is usually printed in the sea chart.

12.3.4 C33 (Auto DEV)

Automatic compass deviation, (see 12.4.1).

12.3.5 C34 (Auto CHK)

Check of automatic compass deviation, (see 12.4.2).

12.3.6 12.3.6 C35 (Auto CLR)

Clear automatic compass deviation memory.

12.3.7 12.3.7 C36 (000°ADJ)

Compass transducer misalignment correction, (see 12.4.4).

12.3.8 C37 (OFF COG)

Select heading transducer to be displayed as main-function under NAVIGATE.

(OFF) = Heading from compass transducer.

(ON) = Heading from navigator, course over ground (COG).

12.3.9 C38 (OFF SEC)

Format of position in latitude and longitude.

(OFF) = Position in degrees, minutes and 100:th of a minute.

Indicated by the sign (.) after the minute.

(ON) = Position in degrees, minutes and seconds.

No sign (.) after the minute.

12.3.10 12.3.10 C39 (0.00 LAT)

Compensation of latitude from WGS-84.

The value should be between - 9,99 and + 9.99 NM.

Use underlining sign (_) for plus. Use minus sign (-) for minus.

12.3.11 12.3.11 C40 (0.00 LON)

Compensation of longitude from WGS-84.

The value should be between - 9,99 and + 9.99 NM.

Use underlining sign (_) for plus. Use minus sign (-) for minus.

Note: In code C39 and C40 the compensation must always be set in 100:th of a minute, independently of the setting in code C38.

12.3.12 C41 (0.10 ARC)

Arrival Circle. Set the radius of the arrival circle, from 0,01 to 9,99 NM.

12.3.13 C42 (RDR). C43 (AP1). C44 (AP2)

These 3 calibration codes are reserved for the Nexus autopilot: .

12.3.14 C45 (Pilot SEA)

Damping for the optional analogue steer pilot instrument.

LOW = 1.3 sec, MID = 2.8 sec. and MAX = 11 sec.

(Available for analogue steer pilot instruments, from version 1.3).

12.3.15 C46 (000 LGD)

Local geodetic datum. Used to set local geodetic datum for the Nexus GPS antenna from the Multi Control instrument.

A list for geodetic datum is supplied with each Nexus GPS antenna.

The antenna is factory set for local geodetic datum WGS-84.

12.3.16 C47 (OFF MAG)

(Available from Multi version 2.0)

(ON) = All headings and bearings will be magnetic.

(OFF) = All headings and bearings will be true.

Note a: In the (Goto WP) function, the bearing for every leg will always be displayed as true bearing.

Note b: The setting is only affects the independent Multi Control instrument in which is set.

12.4 12.4 Compass calibration

12.4.1 Automatic compass deviation compensation (Auto DEV)

(Auto DEV) is performed by driving the boat in a circle up to 1¼ turn, so that the magnetic deviation can be measured, and by that Iso compensated.

Select calibration code C33 (Auto DEV).

Drive the boat in a circle for 1 1/4 turn in calm water. When you start the circle manoeuvre, press **KEY**.

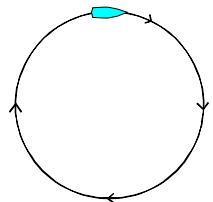

The un-deviated compass course will be shown in the display as you turn. Complete the circle up to 1 ¼ turn.

When the manoeuvre is ready, press **KEY** to store the deviation value.

If the deviation is corrected (Auto DEV) will be displayed.

If the deviation is not corrected, an error message will be displayed.

To verify the automatic compass deviation, perform an automatic compass check (Auto CHK), (see 12.4.2).

Note: You will get the best result in calm water with a smooth turn on the steering wheel independently of how the circle is performed. When activated, you can stop the automatic compass deviation at any time with a press on **DOWN** and **UP** together.

12.4.2 Automatic compass deviation check (Auto CHK)

(Auto CHK) is done by driving the boat in a circle up to 1 ¼ turn, after (Auto DEV) is performed. The result will be compared with (Auto DEV). If the deviation is less than 1,5°, the average value from the comparison between (Auto DEV) and (Auto CHK) will be stored.

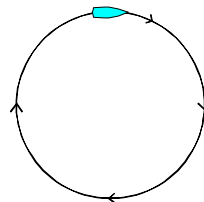

If the check is OK, (Auto CHK) will be displayed.
If not an error message will be displayed.

Select automatic compass check (Auto CHK), press **KEY** and repeat the same circle manoeuvre as described in the (Auto DEV) routine.

Note: As soon as you place any kind of ferrous items close to the compass, the (Auto DEV) / (Auto CHK) routines should be repeated. So if you have packed your boat for the vacation, think about where you place ferrous items in relation to the compass transducer.

12.4.3 Cancel earlier performed compass deviation (Auto CLR)

To cancel earlier (Auto DEV), press **KEY**.

12.4.4 Compass misalignment correction (Adj)

Compass transducer misalignment correction or the so called "A-fault".

Can be set between 000° and 359°. Allows 180° reversed mounting if needed. Never mount the transducer in a 90° position relative to the boats fore-aft line.

To check the transducer position, sail/drive your boat in a straight line towards two visible objects in a line. If the actual heading taken from the sea chart is 330° and the compass displays 335°, then set calibration code C36 value to $360^\circ - 5^\circ = 355^\circ$.

12.5 C50, calibration of wind

12.5.1 C50 (RET)

To return to the normal mode, press KEY.

12.5.2 C37 (OFF COG)

Select type of heading transducer, compass or navigator (COG), to be displayd as main-function under NAVIGATE.

When COG is available (Nexus or NMEA), and no compass transducer is connected, you can set C75 to (ON), COG will also be used to compute TWD (true wind direction)

12.5.3 C51 (OFF TWA)

Select true (TWA) or the apparent wind angle (AWA) as main-function under WIND. The optional analogue wind instrument will display the same selection. All Multi Control instruments which have the calibration code C63 set to (WIA) will display what is selected in C51.

C51 (OFF) = Apparent wind angle displayed.

C51 (ON) = True wind angle displayed.

12.5.4 C52 (Unit m/s)

Unit for wind speed. Metre/second (m/s), knots (KTS) or Beaufort (BF).

12.5.5 C53 (1.50 CAL)

Do not change this factory setting.

12.5.6 C54 (000° ADJ)

Mast top unit misalignment adjust value or the so called "A-fault", makes it possible to choose any horizontal angle.

Example: If the wind angle is +4° when you sail/drive the boat straight into the wind. Set the calibration channel C54 to 356°.

12.5.7 C55-C62 Wind calibration values

In channels C55 to C62 you set the calibration values for the mast top unit. Each mast top unit is individually calibrated for best accuracy.

See the separate wind calibration certificate supplied with each mast top unit. Each of the inter-cardinal directions are calibrated:

C55 (000° 000)

C56 (045° 045)

C57 (090° 090)

C58 (135° 135)

C59 (180° 180)

C60 (225° 225)

C61 (270° 270)

C62 (315° 315)

Set the calibration values according to the calibration certificate.

12.5.8 C63 (WIA)

Select from 5 functions. (WIA) is the factory setting.

Select the function to be displayed as main-function under WIND.

The optional analogue wind instrument will display the same selection.

Select from 5 functions. (WIA) is the factory setting.

If the selected main-function is an angle, the sub-function will show the complimenting angle, e.g. if (AWA) is selected as main-function, (TWA) will be shown as sub-function and vice versa.

If the selected main-function is a wind speed, the sub-function will show the corresponding angle, e.g. if (AWS) is selected, (AWA) will be shown as the sub-function and vice versa for (TWS) and (TWA).

(WIA): True (TWA) or apparent wind angle (AWA).

Depending on what is set in C51, (ON = True, OFF = Apparent).

(AWA): Will display apparent wind angle (AWA) in this instrument independent of what is set in C51.

(TWA): Will display true wind angle (TWA) in this instrument independent of what is set in C51.

(AWS): Will display apparent wind speed (AWS) in this instrument independent of what is set in C51.

The letters (AW) will be displayed to the right of the wind speed.

(TWS): Will display true wind speed (TWS) in this instrument independent of what is set in C51.

The letters (TW) will be displayed to the right of the wind speed value.

12.6 C70, calibration of Network and NMEA

When calibration code C70 is selected, the LCD arrows for all functions will be displayed

12.6.1 C70 (RET)

To return to the normal mode, press **KEY**.

12.6.2 C71 (On KEY)

(On) = Sound when push buttons are pressed. (OFF) = no sound.

12.6.3 C72 (d0 SEA)

Damping of speed and course over ground (SOG/COG), affecting the complete Nexus Network and NMEA output.

d0 = no damping. d1 = 2 sec, d2 = 5 sec, d3 = 10 sec, d4 = 20 sec, d5 = 40 sec, d6 = 1.20 min, d7 = 2.40 min, d8 = 5 min and d9 = 10 min.

12.6.4 C73 (OFF WPR)

Receive waypoints from a NMEA navigator to the Server via the NMEA sentence WPL, (see C78, WBN).

(OFF) = Reception off. (On) = Reception on.

12.6.5 C74 (On WPT)

Transmit waypoints from the Server to a NMEA navigator via the NMEA sentence WPL, (see C78, WBN).

The NMEA sentence WPL must be selected in one slot from C79 to C94 (See 13.1.2.).

(OFF) = Transmission off. (On) = Transmission on.

It takes approximately 200 seconds to transfer 100 waypoints.

12.6.6 C75 (OFF NAV)

Here you select which instrument is navigating.

By the term "navigating", we mean the active instrument in which the waypoint memory is used to calculate the navigation data, i.e. BTW, DTW etc. There can only be one instrument on the Nexus Network which is navigating.

(OFF) = The Server is navigating.

One of the following NMEA position sentences must be received for the Server to calculate navigation data: RMC, GGA, RMA or GLL.

(On) = NMEA navigator is navigating. The Multi Control instrument becomes a repeater of the information transmitted from the NMEA navigator.

See 12.7.3 for the NMEA sentences received by the Server.

Note: If a Nexus GPS is connected, C75 will be ignored, that is the Server will automatically take over the navigation no matter how C75 is set.

12.6.7 C76 (OFF CMP)

(OFF) = Nexus compass. (On) = NMEA compass.

12.6.8 C77 (OFF WIND)

(OFF) = Nexus wind. (On) = NMEA wind.

12.6.9 C78 (00 WBN)

Waypoint block number (1 block = 100).

Example 1: To receive waypoint number 101 to 150 from a NMEA navigator and store them in memory 1 to 50 in the Server, set C78 (WBN) to 01 and C73 (WPR) to On.

Example 2: To transfer waypoint number 1 to 50 from the Server and store them in a NMEA navigator memory number 101 to 150, set C78 WBN to 01 and C74 WPT to On.

12.6.10 C79 to C94

Contains 16 NMEA slots. (See 12.7.1)

12.6.11 12.6.11 C95 (d4 NME)

Damping for NMEA OUT from Server.

Only compass heading (HT/HM) and boat speed through water (BSP) can be damped with this code.

d0 = 0.5 sec, d2 = 1 sec, d3 = 2.5 sec, d4 = 5 sec, d5 = 10 sec,
d6 = 20 sec, d7 = .40 sec, d8 = 80 sec and d9 = 160 sec.

12.7 NMEA

12.7.1 Transmit NMEA sentences OUT from Server

Calibration code C79 to C94 contains 16 NMEA slots

The Server supports 29 different NMEA sentences.

This means you can select up to 16 of the 29 available NMEA sentences.

The Nexus Network uses the NMEA 0183 sentences, version 1.5 and 2.0.

The number in brackets, example (C79), is the calibration code for the factory slot number given to the NMEA sentence.

0	(—)	No out signal
1	(APA)	Autopilot A (older)
2	(APB)	Autopilot B
3	(BOD)	Bearing original destination
4	(BWC)	Bearing and distance to waypoint
5	(C79) (BW1)	Short version of BWC Maxi repeater)
6	(BWR)	Bearing and distance, dead reckoning
7	(C80) (DBT)	Depth measured from the transducers position
8	(DPT)	Depth
9	(C81) (GLL)	Geographic position
10	(C82) (HDM)	Magnetic heading
11	(C83) (HDT)	True heading
	(C91)	
12	(MTW)	Water temperature
13	(C84) (MWD)	Wind direction and speed
14	(MWV)	Apparent wind speed and angle
15	(RMA)	Minimum specific Loran-C data
16	(RMB)	Minimum navigation data
17	(RMC)	Minimum specific GPS- and TRANSIT-data
18	(C85) (VDR)	Set and drift
19	(C86) (VHW)	Speed and course through the water

CALIBRATION

20	(VLW)	Distance travelled through the water
21	(C87) (VPW)	Speed relative to the wind
22	(C88) (VTG)	Distance made good and distance over ground.
23	(C89) (VWR)	Apparent wind speed and wind direction
24	(C90) (VWT)	True wind speed and direction
25	(C92) (WCV)	Waypoint closure velocity
26	(C93) (WPL)	Waypoint location
27	(C94) (XTE)	Cross track error
28	(ZDA)	Time and date
29	(ZTG) & (UTC)	Time to destination or waypoint

Example of NMEA sentences:

```

$IIAPA,A,A,00.007,L,N,V,V,145.03,M,004
$IIAPB,A,A,00.007,L,N,V,V,147.53,T,004,147.52,T,,T*29
$IIBOD,147.53,T,145.03,M,004,000
$IIBWC,101515,5912.890,N,01812.580,E,147.52,T,145.02,M,1
5.649,N,004
$IIBWC,,,,,147.52,T,145.02,M,15.647,N,004
$IIBWR,101516,5912.890,N,01812.580,E,147.52,T,145.02,M,1
5.647,N,004
$IIDBT,293.52,f,089.47,M,048.36,F
$IIDPT,089.47,0.40
$IIGLL,5926.110,N,01756.171,E,101517,A
$IIHDM,026,M
$IIHDT,029,T
$IIMTW,19,C
$IIPWD,161.77,T,159.27,M,07.01,N,03.61,M
$IIWV,133,R,07.03,N,A
$IIRMA,A,5926.110,N,01756.171,E,,,0.23,189.47,,,,*00
$IIRMB,A,00.007,L,000,004,5912.890,N,01812.580,E,15.647,
147.52,,V*01
$IIRMC,101340,A,5926.115,N,01756.172,E,0.04,063.42,,,*06
$IIVDR,063.42,T,060.92,M,0.04,N
$IIVHW,029,T,026,M,00.00,N,00.00,K
$IIVLW,49626.59,N,,
$IIVPW,0.00,N,,
$IIVTG,063.42,T,060.93,M,0.04,N,,
$IIVWR,133,R,07.03,N,03.62,M,,
$IIVWT,133,R,07.01,N,03.61,M,,
$IIWCV,0.00,N,004
$IIWPL,5503.000,N,01013.450,E,027
$IIXTE,A,A,00.003,L,N
$IIZDA,101341,,,,
$IIZTG,101341,,004

```

(BWR) consists of rumb line data, and is the same information as (BWC), except that (BWC) consists of great circle data.

(BWR) is a service for receivers not accepting information that is (BWC).

(BW1) is a shorter version of (BWC), i.e. lacks time and destination waypoint position, will be sent out as a zero string. The transmitted string will be (BWC) and not (BW1) (as in the example). (BW1) is for MAXI-Repeaters.

(WPL) is sent when (C74) is set to (ON), which means that each time (WPL) is transmitted, the contents will be the next defined waypoint and when all have been transmitted it starts again with

the first one etc. the identity Id of all waypoints are transmitted with 3 digits.

It is possible to send and receive waypoints in block of 100 by setting (C78) (WBN) the same as the desired block number.

Example: If (C78) is set to (03), waypoint (23) will be sent as number (323).

Note: All waypoints will be affected alike.

(ZDA) consists only of UTC time. Date is not sent.

12.7.2 Change NMEA sentences OUT from Server

Before you change any of the factory set NMEA sentences, check what NMEA sentences can be received by your NMEA navigator.

Select the slot number for the sentence to be changed, then press **KEY**.

To select the sentence, press **DOWN** or **UP** until found.

To lock the selected sentence, press **KEY**.

One of the advantages with the Nexus Network is the very fast transmission speed of data compared to the relatively slow NMEA standard (about 10 times faster). Therefore we recommend that you use Nexus instruments and transducers for better accuracy.

It takes two seconds to transmit all 16 NMEA sentences.

To double the transmission speed, select a NMEA sentence 2 times with 7 slots apart, that is the slots should be as far away from each other as possible.

In a similar way, you can select the a sentence 4 times to make it 4 times faster.

Example: If you want to transmit the Nexus compass heading via NMEA, to for example an autopilot, select (HDM) for every odd slot number, C79, C81, C83 ... C93, that is 8 times which makes the speed 4 times / second. This leaves the other 8 slots with even numbers, C78, C80, C82 ... C94 free to use for other NMEA sentences.

For connection of NMEA instruments OUT from Server, (see 2.7).

12.7.3 Receive NMEA sentences IN to Server

There are 5 different main types of NMEA sentences:

1) Position related data: Position, SOG/COG, time, and a limited amount of satellite status if a GPS is connected. The information is read if no other Nexus GPS is connected. If a Nexus GPS is connected, it will take over the navigation.

2) Navigation data: (BTW), (DTW), (BOD), (XTE), (SET) and (DRIFT). This information is read only if C75 NAV is set to (ON).

The Server will automatically send data to the Nexus Network. E.g.: (DRIFT), (WCV), (TTG) and (CTS).

3) Waypoint data: Is received from (WPL) data if (C73 WPR) is set to on (ON). Nexus Server version 1.7 and higher can receive (NMEA WP) and re-transmit to an active Nexus navigator through the Nexus Network.

4) Compass heading is read only if (C76 CMP) is set to (ON). Heading is either (HDT) (priority) or (HDM). Magnetic variation (from Nexus Network) is added to (HDM) but not to (HDT).

5) Relative wind angle and wind speed is read from (VWR) data, only if (C77 WND) is set to (ON). True wind angle and wind speed is calculated by Nexus, when the boat speed (the speed of the water) is known.

The following NMEA sentences can be received IN to Server:

AAM	Waypoint arrival alarm
APA	Autopilot sentence "A" (old)
APB	Autopilot sentence "B"
BOD	Bearing original destination
BWC	Bearing and distance to waypoint
BWR	Bearing and distance to waypoint (old)
GGA	Global position fix data (GPS)
GLL	Geographic position, Latitude/Longitude
HDM	Heading, magnetic
HDT	Heading, true
RMA	Minimum specific Loran data
RMB	Minimum navigation information
RMC	Minimum specific GPS/transit data
SNA	Navigation status
VDR	Set & drift
VTG	Track made good and ground speed
VWR	Relative wind speed and direction
WPL	Waypoint location
XTE	Cross-track-error, measured
ZDA	Time & date

For connection of NMEA instrument IN to Server, (see 2.6).

All data (POSITION, BTW, SOG/COG, etc.) is received from one type of NMEA sentence. If data is placed in different locations, the data will be selected from the sentence with the highest priority.

Example I: Position is read in priority order: RMC, GGA, RMA and GLL.

Example II: BTW/DTW is priority first with: RMB, BWC and BWR.

The transmission ID (the first two letters after "\$") is ignored by the Server. Present position is read, after that possible latitude and longitude correction is added (C39 and C40) before the position is sent over the Nexus Network to all instruments

12.8 Special NMEA sentences

The Server can read 2 special NMEA sentences which can be send from a PC. One contains TBS (target boat speed), the other CAD (customised angle data) and CFD (customised fixpoint data). These 3 data are retransmitted on the Nexus Network and can be displayed as a sub-function on the Multi Control instrument.

To get the sub-function TBS, select main function SPEED and the "empty" sub-function. Then press MODE and KEY together followed by UP and DOWN together.

To get the sub-function CAD, select main function NAVIGATE and the "empty" sub-function. Then press MODE and KEY together followed by UP and DOWN together.

To get the sub-function CFD, select main function WIND and the "empty" sub-function. Then press MODE and KEY together followed by UP and DOWN together.

Example of special NMEA-sentence:

\$PSILTBS,X.X,N<CR><LF>

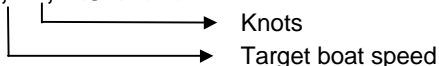

\$PSILCD1,X.X,X.X,<CR><LF>

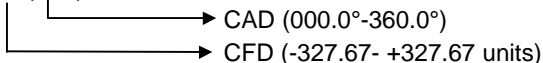

This function is valid form Server version 2.4 and Multi Control instrument version 2.3 or later.

13 Maintenance and fault finding

13.1 Maintenance

- To clean the instrument, use only mild soap solution and rinse with water.
- Do not use detergents or high pressure washing equipment.
- At least once a year, check all your connections and apply additional silicon paste at each connection point.
- Always use the instrument cover for protection, when not in use.
- Storing transducers and instruments when not in use for longer periods: It is advisable to remove the instruments and transducers, and store them inside the boat or at home in room temperature, if possible.



13.2 Fault finding

Before you contact your Nexus dealer, and to assist your dealer to give you a better service, please check the following points and make a list of:

- All connected instrument and transducers, including their software version numbers.
- Server software version number.
- Nexus Network data bus ID numbers for each instrument (displayed at power up).

13.2.1 General

In most cases, the reason for faults in electronic equipment is the installation or poor connections. Therefore, always first check that:

- Installation and connection is made per instructions for instrument and transducers, (see 2).
- Screw terminals are carefully tightened.
- No corrosion on any connection points.
- No loose ends in the wires causing short cuts to adjacent wires.
- Cables for damage, that no cables are squeezed or worn.
- Battery voltage is sufficient, should be at least 10V DC.
- The fuse is not blown and the circuit-breaker has not opened.
- The fuse is of the right type.
- Two instruments do not have the same ID number, (see 3).

13.2.2 Fault - action

1. Speed and distance functions: No reading (---)

- C13 (COG) should be OFF, if no navigator is connected.

If you have a voltmeter available, you can check the condition of the transducer. When measuring with voltmeter check that everything is connected, that the power is on and make sure the paddle wheel is rotating.

At the Server right hand side, measure between pin 2 and 4.

When not rotating, the value should be fixed at either about 0 or 5V DC. When rotating very slowly, by hand, the value should flip between 0 and 5V DC. When rotating faster, the value should average around 2.5V DC.

Irregular values: Check the speed damping (SEA), (see 6.2.7).

2. Compass: No reading (---)

- C76 should be OFF, if no NMEA compass is connected.
- Make sure the (Auto DEV) routine is done correctly, (see 12.4.1)
- Make sure the transducer is not mounted upside down.
- The transducer cable should face down.
- Make sure transducer is aligned correctly, (see 12.3.7, C36).

With a voltmeter, on the Server right hand side, measure between pin 10 and 12, and between 11 and 12.

When the compass is rotated one turn (360*), the average value should vary between 0.8V DC and 4.2V DC twice during the turn.

Irregular values: Check the compass damping (SEA), (see 8.2.3).

Make sure there are no ferrous items close to the transducer.

3. Wind: No reading (---)

- C77 should be OFF, if no NMEA wind is connected.
- If inaccurate wind data is received, check the connections (separate through deck connection or below decks connection), are properly made.
- Measure with a voltmeter, at the Server right hand side pins 14 and 16, and between pins 15 and 16.
- If the voltmeter shows 1.5 to 4V DC (minimum wind speed 3 m/s) at both measuring points, the transducer and the connections are OK,
- If the voltmeter shows 0 or 5 V DC at both measuring points, the transducer or the connections are defect. Contact you Nexus dealer with this information.
- Make sure the transducer is aligned correctly, (see 12.5.6, C54).

4. Navigation:

- Which instrument is navigating? (See 12.6, C75)
- C75 (OFF) = The Server is navigating.
- C75 (ON) = The NMEA navigator is navigating.
- If problem with NMEA IN to Server, (see 12.7 and 12.6.4).
- If problem with NMEA OUT from Server, (see 12.6.7 and 12.6.5).

5. What you should know about digital depth sounders.

The principle of a depth sounder is that you measure the time it takes for a short acoustic signal to go from the transducer to bottom and back again to the transducer.

The echo changes due to bottom character, heavy layers of salt and temperature, irregular bottom vegetation, fish etc. Thanks to an advanced signal treatment, these variations will normally not influence the depth measurement.

You can in some circumstances get transitory disturbances.

Below are listed some explanations for disturbances to the measurement of depth and how it is expressed on the instrument display.

1. There is no depth reading on the display. Only (---) is displayed:

If there are no depth echoes for 3 seconds, the display indicates 3 dotted lines (---) until a new echo is received.

- In deep water outside the range of the transducer, or the combination of deep water and soft bottom which makes it difficult to reflect the signal.
- When the boat is heeling heavily, for example when sailing.
- In a propeller stream, where air bubbles are created. Example when powering astern or when following close behind a power boat.
- Check the connection at the amplifier box. Make sure the cable is correct between, instrument and transducer, as marked on the box.
- Internal mount with poor signal penetration due to a too thick hull, (maximum thickness recommended is 20 - 30 mm) or air between transducer and hull.

2. Unstable or erratic readings. Can happen in the following cases:

- When going over shoal water, with uneven and high bottom vegetation.
- In heavy layers of salt or noticeable ranges of water temperatures.
- In heavily agitated water containing particles of sand or some other contamination.

The bottom of the transducer may be painted with anti fouling for protection against weed growth. It is recommended the transducer is cleaned at regular intervals depending on what kind of waters you boat in.

Weed on the transducer can cause either no reading or unstable readings.

In general when a boat is moored in a harbour with other boats around, there can be disturbances from signals from other depth transducers, chains or other mooring equipment, which will result in wrong depth readings.

13.2.3 Error messages

The following error messages can appear on the display:

- | | |
|-----------------|---|
| ERROR 2 | Nexus Network is missing, check colour coded connections |
| ERROR 3 | No data received within a given time. |
| ERROR 10 | Range error caused by bad format e.g. 17° 70' East. |
| ERROR 11 | Remote command that can not be performed. |
| ERROR 12 | No response from, or missing navigator. |
| ERROR 13 | Waypoint not defined. |
| ERROR 15 | Functions not allowed in autopilot mode. |
| ERROR 16 | Automatic deviation not possible due to NMEA compass selected. |
| ERROR 17 | Automatic deviation check failed. Turn not completed, error larger than 1,5°. |
| ERROR 19 | The boat probably hit a wave during turn. Error larger than 1,5°. |

If other error messages than the above appears on the Multi Control instrument, contact your Nexus dealer.

14 Specifications

14.1 Technical specifications

Dimensions:	Multi Control instrument: 110 x 10 x23 mm (4.3x4.3 inch). Server: 110 x 165 x 30 mm. (4.3x6.5x1.2 inch)
Instrument cable:	8 m (26 ft).
Power supply:	12V DC (10-16V). The instruments are polarity protected
Power consumption at 12V:	Multi Control instrument: 0,08W with maximum lighting 0,8W. Server: 0,2W.
Temperature range:	Storage: -30°to +80°C (-22°to +176°F) Operation: -10° to +70°C(14°to +158°F)
Weight:	Multi Control instrument: 260 gram (9.17 oz). Server: 220 gram. (7.76 oz).
Enclosure:	Multi Control Instrument: Water proof Server: Splash proof

CE approval

The products conforms to the EMC requirements for immunity and emission according to EN 50 08-1.

14.2 Nexus databus introduction and user policy

Introduction:

The Nexus data bus is a multi talker multi receiver data bus specially designed for marine navigation applications. It utilises the RS485 standard with up to 32 senders and/or receivers to form a Local Area Network. Data is transmitted synchronously with 1 start-bit, 8-data-bits, 1 parity-bit, two stop-bits in 9600 baud.

User policy:

The Nexus data bus is open for new users and applications without the a licence or a licence fee. The data bus is, however, the property of the manufacturer, which means the specification must be followed in order to protect the manufacturer's commitments to the Nexus data bus performance and safety.

For most PC-applications, the full duplex interface (Art. No. 21248), will be a very useful tool for monitoring real time data, to edit and store waypoints to PC-file or to Server and/or to the Nexus GPS. The interface is supplied with a cable for connection from PC to the Server or Nexus instruments and/or the Nexus GPS. A 9-pole D-sub connector is connected to the RS232 port on the PC.

14.3 Optional Accessories

Below find a selection of optional accessories available. Please contact your local Nexus dealer for more information.

Art. No. **Nexus Complete Sets:**

20445-3	Multi Control instrument with Server
20445-1	Speed log, complete with transducer
20445-2	Depth, complete with transducer.
21033-1	GPS Navigator, complete with instrument and antenna

Nexus Digital Repeaters:

20445-4.	Multi Control
21032	GPS Navigator, Nexus/NMEA
20445-5	Autopilot instrument
21210	Remote Control, Nexus remote and instrument

Nexus Analogue Repeaters:

20550-1	Wind
20550-2	Steer Pilot
20550-6	Compass
20550-3	Log, 0-16 KTS
20550-4	Log, 0-50 KTS
20550-5	Depth, 0-200 m
20550-7	Depth, 0-600 FT
20550-8	Speed Trim
20550-9	Rudder Angle indicator

Nexus Transducers:

20700	Log/Temp,0 - 30 KTS, retractable, 8 m (26 ft) cable
20711-2	Depth, 0.8 - 150 m (2.6-490 ft), retractable, 3 + 8 m (10 + 26 ft) cable
20721	Mast Top Unit, 22 m (72 ft) cable
20860	Fluxgate compass, 8 m (26 ft) cable
21000	GPS Antenna, Nexus/NMEA, fix, 10 m (33 ft) cable
21117	GPS Compass XL1000, portable,
21170	GPS Navigator XL300, portable,

Nexus inboard hydraulic Autopilot

21035	Servo unit
21134	Pumpset hydraulic steering
21134	Pumpset complete with cylinder and solenoid
21036	Rudder angle transmitter

Other Nexus Accessories

19841	Maxi repeater via NMEA, yellow digits
19941	Maxi repeater via NMEA, red digits
19923	Single bracket for Maxi repeater
69999	Double bracket for Maxi repeater

SPECIFICATIONS

21248	Nexus FD interface. PC interface with 1m (3.3 ft) cable. Includes a 3½"disc. with software for waypoint editing and a data bus manager and NMEA interface
19763	Push button for Tactical and MOB function
21154	High Speed Paddle wheel, up to 40 KTS
19038	Internal mounting kit for depth transducer
19216	Bronze through hull fitting
18129	Instrument panel in aluminium for up to 6 Nexus instruments
18500	Through deck connector 7-pole
18501	Through deck connector 4-pole
20966	Connector 4-pole

14.5 Abbreviations

Abbreviation. Description

A	Angle
ADJ	ADJust
ANC	ANChor
ANC	ANChor alarm
Arrival	Arrival
ARC	Arrival Circle
AVS	Average Speed
AWA	Apparent Wind Angle
AWS	Apparent Wind Speed
BAT	BATtery
BF	BeauFort
BOD	Bearing Original Destination
BSP	Boat Speed
BTW	Bearing To Waypoint
C	Celsius
CE	Communaute Européenne
C10	Calibrate 10
CAL	Calibrate
CG	Course over Ground
CHK	CHeck
CLR	CLeaR
CMG	Course Made Good
CMP	CoMPass
COG	Course Over Ground
CTS	Course To Steer
CU	Central Unit
d	differential
D/R	Dead Reckoning
DEFAULT	Factory setting
DEV	DEViation
DMG	Distance Made Good
DEA	DEpth Alarm
DPT	DePTH
DRF	DRiFt, Speed of current
DST	DiSTance
DTW	Distance To Waypoint
E	East
EDIT	EDIT
EMC	Electro Magnetic Compatibility
EN	European Norm
F	Fahrenheit
F1-F9	Figure of merit
FA	Fathoms
FREE	FREE
FT	FeeT
GLL	Geographic Latitude Longitude
GoTo	Go To
GPS	Global Positioning Network

SPECIFICATIONS

HDM	HeaDing Magnetic
HDT	HeaDing True
HM	Heading Magnetic
HT	Heading True
id	Identity
Init	Initiation
Insert	Insert
Km	Kilometre per hour
KT	KnoTs
KTS	KnoTS
L	Local
LAT	LATitude
LCD	Liquid Crystal Display
LGD	Local Geodetic Datum
LOG	LOG
LON	LONgitude
LOW	LOW
MAX	MAX
m/s	metres per second
MEM	MEMory
Mh	Miles per hour
MID	MID
MN	Magnetic North
MOB	Man Over Board
m	metre
N	North
NAV	NAVigate
NM	Nautical Mile
NMEA	National Marine Electronic Association
NXT	NeXT
OCA	Off Course Alarm
RET	RETurn
Roll	Roll
S	South
S/A	Selective Availability
SAT	SATellite
SEA	SEA
SEC	SEConds
SET	SET, Direction of current
SHA	SHallow Alarm
SOG	Speed Over Ground
STA	STArt
STR	STeeR
SW	South West
TAC	TACTical
TMP	TeMPerature
TRP	TRiP
TTG	Time To Go
TWA	True Wind Angle
TWS	True Wind Speed
UTC	Universal Time Co-ordinate

SPECIFICATIONS

VAR	VARiation
VMG	Velocity Made Good
W	West
WCV	Waypoint Closure Velocity
WP	Waypoint
XTE	Cross Track Error
-	Minus
+	Plus
	Wind from port side
	Wind from starboard side
	The boat is left of the desired track
	The boat is right of the desired track

WARRANTY

GENERAL

All our products are designed and built to comply to the highest class industry standards. If the products are correctly installed, maintained and operated, as described in the installation and operation manual, they will provide long and reliable service. Our international Network of distributors can provide you with the information and assistance you may require virtually anywhere in the world.

Please read through and fill in this warranty card and send it to your national distributor for product registration.

LIMITED WARRANTY

The warranty covers repair of defective parts due to faulty Manufacturing and includes labour when repaired in the country of purchase. The warranty period is stated in the product manual, and commences from the date of purchase. The above warranty is the Manufacturer's only warranty and no other terms, expressed or implied, will apply. The Manufacturer specifically excludes the implied warranty of merchantability and fitness for a particular purpose.

CONDITIONS

- The supplied warranty card and receipt with proof of purchase date, must be shown to validate any warranty claim. Claims are to be made in accordance with the claims procedure outlined below.
- The warranty is non-transferrable and extends only to the original purchaser.
- The warranty does not apply to Products from which serial numbers have been removed, faulty installation or incorrect fusing, to conditions resulting from improper use, external causes, including service or modifications not performed by the Manufacturer or by its national distributors, or operation outside the environmental parameters specified for the Product.
- The Manufacturer will not compensate for consequential damage caused directly or indirectly by the malfunction of its equipment. The Manufacturer is not liable for any personal damage caused as a consequence of using its equipment.
- The Manufacturer, its national distributors or dealers are not liable for charges arising from sea trials, installation surveys or visits to the boat to attend to the equipment, whether under warranty or not. The right is reserved to charge for such services at an appropriate rate.
- The Manufacturer reserves the right to replace any products returned for repair, within the warranty period, with the nearest equivalent, if repair within a reasonable time period should not be possible.
- The terms and conditions of the warranty as described do not affect your statutory rights.

CLAIMS PROCEDURE

Equipment should be returned to the national distributor, or one of its appointed dealers, in the country where it was originally purchased. Valid claims will then be serviced and returned to the sender free of charge.

Alternatively, if the equipment is being used away from the country of purchase, it may be returned to the national distributor, or one of its appointed dealers, in the country where it is being used. In this case valid claims will cover parts only. Labour and return postage will be invoiced to the sender at an appropriate rate.

DISCLAIMER

Common sense must be used at all times when navigating and the Manufacturer's navigation equipment should only be considered as aids to navigation.

The Manufacturers policy of continuous improvement may result in changes to product specification without prior notice.

File id:

WARRANTY CARD

TO BE RETURNED TO YOUR NATIONAL DISTRIBUTOR

OWNER:

Name: _____

Street : _____

City/Zip Code : _____

Country: _____

Product name:

Serial number:

	A	B	C	1	2	3	4	5	6	7
_____	<input type="checkbox"/>	<input type="checkbox"/>	<input type="checkbox"/>	<input type="checkbox"/>	<input type="checkbox"/>	<input type="checkbox"/>	<input type="checkbox"/>	<input type="checkbox"/>	<input type="checkbox"/>	<input type="checkbox"/>
_____	<input type="checkbox"/>	<input type="checkbox"/>	<input type="checkbox"/>	<input type="checkbox"/>	<input type="checkbox"/>	<input type="checkbox"/>	<input type="checkbox"/>	<input type="checkbox"/>	<input type="checkbox"/>	<input type="checkbox"/>
_____	<input type="checkbox"/>	<input type="checkbox"/>	<input type="checkbox"/>	<input type="checkbox"/>	<input type="checkbox"/>	<input type="checkbox"/>	<input type="checkbox"/>	<input type="checkbox"/>	<input type="checkbox"/>	<input type="checkbox"/>
_____	<input type="checkbox"/>	<input type="checkbox"/>	<input type="checkbox"/>	<input type="checkbox"/>	<input type="checkbox"/>	<input type="checkbox"/>	<input type="checkbox"/>	<input type="checkbox"/>	<input type="checkbox"/>	<input type="checkbox"/>
_____	<input type="checkbox"/>	<input type="checkbox"/>	<input type="checkbox"/>	<input type="checkbox"/>	<input type="checkbox"/>	<input type="checkbox"/>	<input type="checkbox"/>	<input type="checkbox"/>	<input type="checkbox"/>	<input type="checkbox"/>
_____	<input type="checkbox"/>	<input type="checkbox"/>	<input type="checkbox"/>	<input type="checkbox"/>	<input type="checkbox"/>	<input type="checkbox"/>	<input type="checkbox"/>	<input type="checkbox"/>	<input type="checkbox"/>	<input type="checkbox"/>

Date of purchase: _____ Date installed _____

Dealers stamp:

Tick here if you do not wish to receive news about future products

NEXUS MULTI CONTROL

SPEED		DEPTH		NAVIGATE		WIND	
L/N	L	D	D	C/N	C/N	W/W+L	W/W+L
6.05 KT		23 m		270° HT		30° -1A	
12345 TRP	L	30'SHA	D	Pilot MEM	C/NL/W	102 AWS	W
12345 LOG	L	300'IEA	D	2800 STR	C/NL/W	37° -1AWA	W
- 10'STA	L	AWC	D	SEA LOW	C	SEA LOW	W
1204'S2	L	20°C TMP	L+S	560 S0G	N	77 TWS	W+L
12345 DST	L	133 BAT	S	2830 BTW	N	2260 SW	W+L
456 AWS	L	605 DSP	L	005 dH	N	2650 TAC	W+L+C
SEA LOW	L	2700 HDT	C	Ed. t WP	C+N	402 WCV	W+L
23 m	D	07:35 S9U	GPS	6060 WP	N	440 VMB	L/L+W
2790 CMB	L+C	1342 TTG	N	6055'IBN	N	2400 SET	N
12.34 BTW	N			F 4' SAT	GPS	18° T ROH	N+L+C

L=Log	D=Depth	C=Compass	N=Navigator	W=Wind	S=Server
-------	---------	-----------	-------------	--------	----------